

MADE FOR
CHEFS



Cutlery-Pro®

We are professional for
THE PROFESSIONAL

The Cutlery-Pro® Steel

Select high carbon German no-stain alloy steel, which has evolved over the years as the most perfect alloy for superior knife making.

Our formula are proud etched onto every blade:

X 50 Cr MoV15

X = Surgical Steel.

50 = 0.5% carbon, The carbon contents is significant for the sharpness, edge retention and honing of the blades.

Cr = Chromium for stain-resistant properties.

V = Vanadium.

15 = Contents of chromium in % (15%).



The Cutlery-Pro® Forged Knife

The Bolster, an integral part of the knife's construction, it provides balance, safety, heft and authority. Precision Forged, Perfectly balance and shaped. The exclusive —Cutlery-Pro®— look... Skillfully Honed —Cutlery-Pro®— cutting edge, Laser Angle tested, Enhanced Sharpness, Edge Holding & Ease of Re-Sharpenering.

Ergonomic, Slip resistant with Santoprene, Softgrip plastic resin. Seamless Design on Handle, NSF Certified, meet health and safety standard, Dishwasher Safe and SteriShield Anti-Bacterial protection available.



—Cutlery-Pro®—, a leading manufacturer of Professional cutlery since 1981.

The Brand was Registered and Patent in U.S.A

—Cutlery-Pro®— maintained a tradition of excellence in both Material and Workmanship on the products.

We produce the broadest line of Professional cutlery for Commercial, Food Service, Catering and Retail markets.

We are professional for THE PROFESSIONAL.

Check our —Cutlery-Pro®— products and you will find our wide range of Professional Knives, Specialized Knives & Ancillaries, Bakery & Confectionery are available for your selection.

—Cutlery-Pro®— products are the Valued and Cherished tools for the most distinguished Chefs worldwide.

We thank you for your support, now and forever.

美国品牌 营销全球 一体锻造德国钢材



吉利宝®



秀藏作®



专业的产品给专业的您

—Cutlery-Pro®— 是一家历史悠久, 专门生产专业级刀具, 厨具及烘焙专业用品的美国注册品牌, 自1981年成立至今, 分别在世界各地荣获多项注册专利。

—Cutlery-Pro®— 的宗旨贯彻始终: 坚持使用最优质的钢材, 由经验丰富的刀匠, 配以现代科技设备和传统工艺技术, 经千锤百炼, 制造出独特而出类拔萃的刀具, 厨具及烘焙专业用品。

—Cutlery-Pro®— - 专业的产品给专业的您。

—Cutlery-Pro®— 全线生产系列包括热锻造高级厨房刀, 中厨文刀, 桑刀, 文武刀, 武刀, 九江刀系列, 传统日厨牛刀, 三德刀, 出刃, 菜切及柳刃等系列, HACCP彩柄 西厨系列, 雕刻辅助厨具及烘焙专业用品用具。

—Cutlery-Pro®— 产品畅销世界各国的餐饮业, 酒店业, 厨师学校, 屠宰业及零售业, —Cutlery-Pro®— 的产品是世界顶级厨师珍而重之的工作伙伴, 深受各界好评。

感谢各界的厚爱及垂询, 真诚与客户携手合作, 共创未来。

CATALOGUE

目录

Professional Knives 专业刀具

Classic Pro,Cherry 专业经典,热锻系列



Plaza 传统,西厨系列



Pro-Grip HACCP,西厨系列



Chinese Knives 厨王,中厨系列



Damascus Knives 大马士革,锤纹系列



Japanese Knives 专业/牛刀,日厨系列



Classic Pro,Forged 专业经典,热锻系列



Elite-Pro,Forged 精英,热锻系列



Rosewood-Pro 黑檀,西厨系列



Pro-Tex BUTCHER,屠宰系列



Steri-Rox 创新,西厨系列



Specialized Knives 专业刀具



Damascus Knives 大马士革,锦缎系列



Japanese Knives 专业/牛刀,日厨系列



Ancillaries 西厨辅助刀具

Culinary Instruments 西铲烘焙系列



Pro-Touch 雕饰系列



Serving & Accessories 服务工具及配件



Culinary, Rosewood Instruments 黑檀,西铲烘焙系列



Shears 厨房剪刀系列



Knives Accessories

刀具配件

Sharpener

磨刀器具



Sharpening Steel

磨刀棒



Magnetic Holder

磁力架



Knife Guard

刀套



Knife Pouch

刀袋套装



Bakery & Confectionery

烘焙专业用品

Pastry Bags

奶油袋



Decoration Tubes

花嘴



Scraper

切丝刮



Pastry Cutter

饼模



Triangular Croissant Cutters 法式切包器

Roller Dockers

分条刀



Whip

打蛋器



Expandable Dough Cutter

轮刀



Spatula

刮,硅胶





We are professional for
THE PROFESSIONAL



Superior Steel:

German Molybdenum
Vanadium X50CrMoV15
Steel Alloy.

精选德国高级钼钒钢材X50CrMoV15。



Razor-Sharp Edge:

Skillfully Honed —Cutlery-Pro®
Cutting Edge, Laser Angle Tested,
Enhanced Sharpness, Edge Holding &
Ease of Re-Sharping.

技术团队经长时间精心钻研, 寻求不同用途的刀,
对刀刃角度的要求, 在锋利及耐用两方面取得平衡,
形成 —Cutlery-Pro®— 独特的刀刃加工技术, 配合以
雷射角度测试仪来控制产品的质量, 保证刀具的刀刃
锋利, 持久耐用及锻修容易, 刀刃口不易崩缺或断裂。



NSF Certified:

NSF Certified, meet health and safety
standards, Dishwasher Safe and SteriShield®
Anti-Bacterial protection available.

—Cutlery-Pro®— 刀具通过 **NSF** 美国国家卫生基金会
(National Sanitation Foundation) 认证;
配合 —Cutlery-Pro®— 专利的抗菌设计 SteriShield®,
产品的卫生安全更有保证。产品设计不留缝隙驳口,
可放入洗碗碟机清洗, 方便卫生。



Hot Drop Forged:

One Piece Hot Drop Forged,
Full Tang With Three Rivert
Design.

一体热锻而成, 配以冰锻 (Ice Hardened)
技术处理, 令刀锋更持久锋利, 坚韧耐用。



Safe Touch:

Ergonomic, Slip Resistant with
Derlin®, DuPONT® resin.
Seamless Design on Handle.

刀具以崭新的人体工学作为设计基础蓝本,
手柄的指撑设计, 配合美国杜邦公司 Delrin® 注塑材料,
握感平衡舒适, 稳固不滑, 长时间使用轻松自如。
手柄不会脱落。

HACCP Color Coding
HACCP系列颜色分类说明



CLASSIC KNIFE ANALYSIS



CLASSIC

The Evolution Of A Precision Forged Knife

CLASSIC PRO, FORGED

专业经典, 热锻系列



- One Piece Hot Drop Forged From German Molybdenum Vanadium X50CrMoV15 Steel Alloy, Ice-Hardened available.
- Skillfully Honed —Cutlery-Pro®— cutting Edge, Laser Angle Tested, Enhanced Sharpness, Edge Holding & Ease of Re-Sharping.
- Ergonomic, Slip Resistant with Derlin®, DuPONT® resin. Seamless Design on Handle.
- NSF Certified , meet health and safety standards, Dishwasher Safe and SteriShield® Anti-Bacterial protection.







- 精选德国高级钼钒钢材X50CrMoV15一体热锻而成, 配以冰锻 (Ice Hardened) 技术处理, 令刀锋更持久锋利, 坚韧耐用。
- 技术团队经长时间精心钻研, 寻求不同用途的刀, 对刀刃角度的要求, 在锋利及耐用两方面取得平衡, 形成 —Cutlery-Pro®— 独特的刀刃加工技术, 配合以雷射角度测试仪来控制产品的质量, 保证刀具的刀刃锋利, 持久耐用及锻修容易, 刀刃口不易崩缺或断裂。
- —Cutlery-Pro®— 刀具以崭新的人体工学作为设计基础蓝本, 手柄的指撑设计, 配合美国杜邦公司Delrin® 注塑材料, 握感平衡舒适, 稳固不滑, 长时间使用轻松自如。手柄不会脱落。
- —Cutlery-Pro®— 刀具通过  美国国家卫生基金会 (National Sanitation Foundation) 认证; 配合 —Cutlery-Pro®— 专利的抗菌设计SteriShield®, 产品的卫生安全更有保证。产品设计不留缝隙驳口, 可放入洗碗碟机清洗, 方便卫生。

professional kitchen ware & equipment



Forged Peeling Knife





雕花刀

			
FR-9807-65-BK301-CP-CP	2.5" (65mm)		24



Forged Paring Knife

果皮刀

			
FR-9806-100-BK301-CP-CP	4" (100mm)		24



Forged Steak Knife

牛扒刀





			
FR-9802-130-BK301-CP-CP	5" (130mm)		24



Forged Boning Knife

-Straight & Narrow Blade

骨刀, 直身, 超窄





			
FR-9808-150-BK301-CP-CP	6" (150mm)		24

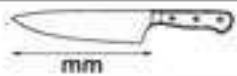

Forged Boning Knife

-Straight & Narrow Blade, Semi Flex

骨刀, 直身, 超窄, 半弹

			
FR-9808-150SF-BK301-CP-CP	6" (150mm)		24



Forged Utility Knife





万用刀

			
FR-9805-150-BK301-CP-CP	6" (150mm)		24



Forged Cheese Knife

芝士刀

			
FR-9864-160-BK301-CP-CP	6.25" (160mm)		24



Forged Carving Fork





叉

			
FR-9244-150-BK301-CP-CP	6" (150mm)		24

Forged Santoku Knife

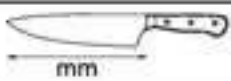
-Granton

三德刀, 欧式, 圆牙





			
FR-9821-180G-BK301-CP-CP	7"(180mm)		24

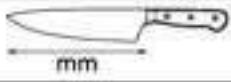

Forged Cleaver Knife

-Chopper

日式武刀





			
FR-9835-180-BK301-CP-CP	7"(180mm)		24



Forged Cleaver, Slicer Knife

-Granton





日式文刀, 圆牙

			
FR-9834-180G-BK301-CP-CP	7"(180mm)		24

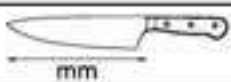

Forged Bread Knife

面包刀





			
FR-9855-230-BK301-CP-CP	9"(230mm)		24

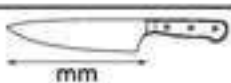

Forged Roast Slicer Knife

-Plain

火腿刀, 平口





			
FR-9866-250P-BK301-CP-CP	10"(250mm)		24



Forged Roast Slicer Knife

-Serrated

火腿刀, 齿





			
FR-9866-250S-BK301-CP-CP	10"(250mm)		24

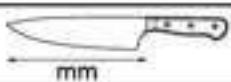

Forged Roast Slicer Knife

-Granton





火腿刀, 圆牙

			
FR-9866-250G-BK301-CP-CP	10"(250mm)		24

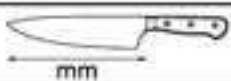

Forged Carving Knife







切肉刀

			
FR-9804-200-BK301-CP-CP	8"(200mm)		24
FR-9804-250-BK301-CP-CP	10"(250mm)		24



Forged Cooks Knife

厨刀







			
FR-9801-200-BK301-CP-CP	8"(200mm)		24
FR-9801-250-BK301-CP-CP	10"(250mm)		24



Forged Cooks Knife

-Wide





厨刀, 宽

			
FR-9801-200W-BK301-CP-CP	8"(200mm)		24
FR-9801-250W-BK301-CP-CP	10"(250mm)		24



Forged Cooks Knife

厨刀

			
FR-9801-300-BK301-CP-CP	12"(300mm)		24



CLASSIC PRO, CHERRY

专业经典, 热锻系列



- One Piece Hot Drop Hammer Forged From German Molybdenum Vanadium X50CrMoV15 Steel Alloy, Ice-Hardened available.
- Skillfully Honed —Cutlery-Pro®— cutting Edge, Laser Angle Tested, Enhanced Sharpness, Edge Holding & Ease of Re-Sharpening.
- Ergonomic, Slip Resistance with European made CHERRY RED Acrylic & Seamless Design on Handle.
- NSF Certified , meet health and safety standards, Dishwasher Safe and SteriShield® Anti-Bacterial protection.







- 精选德国高级钼钒钢材X50CrMoV15一体热锻而成, 配以冰锻 (Ice Hardened) 技术处理, 令刀锋更持久锋利, 坚韧耐用。
- 技术团队经长时间精心钻研, 寻求不同用途的刀, 对刀刃角度的要求, 在锋利及耐用两方面取得平衡, 形成 —Cutlery-Pro®— 独特的刀刃加工技术, 配合以雷射角度测试仪来控制产品的质量, 保证刀具的刀刃锋利, 持久耐用及锻修容易, 刀刃口不易崩缺或断裂。
- —Cutlery-Pro®— 刀具以崭新的人体工学作为设计基础蓝本, 手柄的指撑设计, 配合欧洲制造的CHERRY RED 材料, 握感平衡舒适, 稳固不滑, 长时间使用轻松自如。手柄不会脱落。
- —Cutlery-Pro®— 刀具通过  美国国家卫生基金会 (National Sanitation Foundation) 认证; 配合 —Cutlery-Pro®— 专利的抗菌设计SteriShield®, 产品的卫生安全更有保证。产品设计不留缝隙驳口, 可放入洗碗碟机清洗, 方便卫生。



Forged Peeling Knife



雕花刀

			
FR-9707-65-CP-CP	2.5" (65mm)		24



Forged Paring Knife

果皮刀

			
FR-9706-100-CP-CP	4" (100mm)		24



Forged Steak Knife

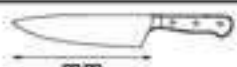

牛扒刀

			
FB-8802-115-BK201-CP-CP	4.5" (115mm)		24



Forged Boning Knife
-Straight & Narrow Blade





骨刀, 直身, 超窄

			
FR-9708-150-CP-CP	6" (150mm)		24



Forged Boning Knife
-Straight & Narrow Blade, Semi Flex





骨刀, 直身, 超窄, 半弹

			
FR-9708-150SF-CP-CP	6" (150mm)		24



Forged Utility Knife





万用刀

			
FR-9705-150-CP-CP	6" (150mm)		24



Forged Cheese Knife





芝士刀

			
FR-9764-160-CP-CP	6.25" (160mm)		24



Forged Carving Fork





叉

			
FR-9744-150-CP-CP	6" (150mm)		24

Forged Santoku Knife

-Granton

三德刀, 欧式, 圆牙



			
FR-9721-180G-CP-CP	7"(180mm)	●	24



Forged Cleaver Knife

-Chopper

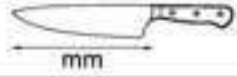
日式武刀





			
FR-9735-180-CP-CP	7"(180mm)	●	24



Forged Cleaver, Slicer Knife

-Granton



日式文刀, 圆牙

			
FR-9734-180G-CP-CP	7"(180mm)	●	24

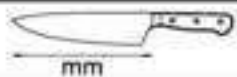

Forged Bread Knife

面包刀



			
FR-9755-230-CP-CP	9"(230mm)	●	24



Forged Roast Slicer Knife

-Plain

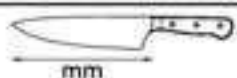
火腿刀, 平口



			
FR-9766-250P-CP-CP	10"(250mm)	●	24



Forged Roast Slicer Knife

-Serrated

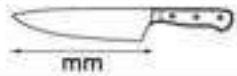
火腿刀, 齿



			
FR-9766-250S-CP-CP	10"(250mm)	●	24



Forged Roast Slicer Knife

-Granton

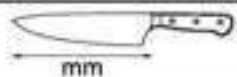

火腿刀, 圆牙

			
FR-9766-250G-CP-CP	10"(250mm)	●	24



Forged Carving Knife

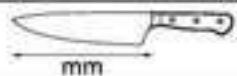

切肉刀

			
FR-9704-200-CP-CP	8"(200mm)	●	24
FR-9704-250-CP-CP	10"(250mm)	●	24

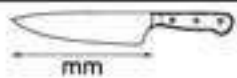

Forged Cooks Knife

厨刀





			
FR-9701-200-CP-CP	8"(200mm)	●	24
FR-9701-250-CP-CP	10"(250mm)	●	24



Forged Cooks Knife

-Wide





厨刀, 宽

			
FR-9701-200W-CP-CP	8"(200mm)	●	24
FR-9701-250W-CP-CP	10"(250mm)	●	24



Forged Cooks Knife

厨刀

			
FR-9701-300-CP-CP	12"(300mm)	●	24



ELITE-PRO, FORGED

精英, 热锻系列



- One Piece Hot Drop Forged From German Molybdenum Vanadium X50CrMoV15 Steel Alloy, Ice-Hardened available.
- Skillfully Honed —Cutlery-Pro®— cutting Edge, Laser Angle Tested, Enhanced Sharpness, Edge Holding & Ease of Re-Sharpening.
- Ergonomic, Slip Resistant with Santoprene® resin. Seamless Design on Handle.
- NSF Certified **NSF**, meet health and safety standards, Dishwasher Safe and SteriShield® Anti-Bacterial protection.



- 精选德国高级钼钒钢材X50CrMoV15一体热锻而成, 配以冰锻 (Ice Hardened) 技术处理, 令刀锋更持久锋利, 坚韧耐用。
- 技术团队经长时间精心钻研, 寻求不同用途的刀, 对刀刃角度的要求, 在锋利及耐用两方面取得平衡, 形成 —Cutlery-Pro®— 独特的刀刃加工技术, 配合以雷射角度测试仪来控制产品的质量, 保证刀具的刀刃锋利, 持久耐用及锻修容易, 刀刃口不易崩缺或断裂。
- —Cutlery-Pro®— 刀具以崭新的人体工学作为设计基础蓝本, 手柄的指撑设计, 配合美国Santoprene® 橡胶材料, 握感平衡舒适, 稳固不滑, 长时间使用轻松自如。手柄不会脱落。
- —Cutlery-Pro®— 刀具通过 **NSF** 美国国家卫生基金会 (National Sanitation Foundation) 认证: 配合 —Cutlery-Pro®— 专利的抗菌设计SteriShield®, 产品的卫生安全更有保证。产品设计不留缝隙驳口, 可放入洗碗碟机清洗, 方便卫生。



Forged Peeling Knife

雕花刀

FB-8807-65-BK201-CP-CP	2.5" (65mm)	●	24



Forged Paring Knife

果皮刀

FB-8806-90-BK201-CP-CP	3.5" (90mm)	●	24



Forged Steak Knife

-Micro Serrated

牛扒刀, 幼齿

FB-8802-115MS-BK201-CP-CP	4.5" (115mm)	●	24



Forged Boning Knife

-Straight & Narrow Blade

骨刀, 直身, 超窄

FB-8808-150-BK201-CP-CP	6" (150mm)	●	24



Forged Boning Knife

-Straight & Narrow Blade, Semi Flex

骨刀, 直身, 超窄, 半弹

FB-8808-150SF-BK201-CP-CP	6" (150mm)	●	24



Forged Utility Knife

万用刀

FB-8805-150-BK201-CP-CP	6" (150mm)	●	24



Forged Cheese Knife

芝士刀

FB-8864-160-BK201-CP-CP	6.25" (160mm)	●	24



Forged Carving Fork

叉

FB-8244-150-BK301-CP-CP	6" (150mm)	●	24



Forged Carving Fork

-Curved

叉, 弯

FB-8244-130C-BK301-CP-CP	5" (130mm)	●	24
FB-8244-150C-BK301-CP-CP	6" (150mm)	●	24

Forged Santoku Knife

-Granton

三德刀, 欧式, 圆牙

Shopping Cart	mm	Icon	Box
FB-8811-130G-BK201-CP-CP	5"(130mm)	●	24
FB-8811-180G-BK201-CP-CP	7"(180mm)	●	24

Forged Cleaver Knife

-Chopper

日式武刀

Shopping Cart	mm	Icon	Box
FB-8835-180-BK201-CP-CP	7"(180mm)	●	24

Forged Cleaver, Slicer Knife

-Granton

日式文刀, 圆牙

Shopping Cart	mm	Icon	Box
FB-8834-180G-BK201-CP-CP	7"(180mm)	●	24

Forged Bread Knife

面包刀

Shopping Cart	mm	Icon	Box
FB-8855-230-BK201-CP-CP	9"(230mm)	●	24

Forged Bread Knife

-Offset

面包刀, 曲

Shopping Cart	mm	Icon	Box
FB-8855-230FS-BK201-CP-CP	9"(230mm)	●	24

Forged Bread Knife

-Wide

面包刀, 宽

Shopping Cart	mm	Icon	Box
FB-8855-250W-BK201-CP-CP	10"(250mm)	●	24

Forged Roast Slicer Knife

-Plain

火腿刀, 平口

Shopping Cart	mm	Icon	Box
FB-8866-250P-BK201-CP-CP	10"(250mm)	●	24
FB-8866-300P-BK201-CP-CP	12"(300mm)	●	24

Forged Roast Slicer Knife

-Serrated

火腿刀, 齿

Shopping Cart	mm	Icon	Box
FB-8866-250S-BK201-CP-CP	10"(250mm)	●	24
FB-8866-300S-BK201-CP-CP	12"(300mm)	●	24

Forged Roast Slicer Knife

-Granton

火腿刀, 圆牙

Shopping Cart	mm	Icon	Box
FB-8866-250G-BK201-CP-CP	10"(250mm)	●	24
FB-8866-300G-BK201-CP-CP	12"(300mm)	●	24

Forged Carving Knife

切肉刀

Shopping Cart	mm	Icon	Box
FB-8804-150-BK201-CP-CP	6"(150mm)	●	24
FB-8804-200-BK201-CP-CP	8"(200mm)	●	24
FB-8804-230-BK201-CP-CP	9"(230mm)	●	24
FB-8804-250-BK201-CP-CP	10"(250mm)	●	24

Forged Cooks Knife

厨刀

Shopping Cart	mm	Icon	Box
FB-8801-150-BK201-CP-CP	6"(150mm)	●	24
FB-8801-200-BK201-CP-CP	8"(200mm)	●	24

Forged Cooks Knife

厨刀

Shopping Cart	mm	Icon	Box
FB-8801-250-BK201-CP-CP	10"(250mm)	●	24



- Stamped From German Molybdenum Vanadium X50CrMoV15 Steel Alloy, Ice-Hardened available.
- Skillfully Honed —Cutlery-Pro®— cutting Edge, Laser Angle Tested, Enhanced Sharpness, Edge Holding & Ease of Re-Sharpening.
- Ergonomic, Slip Resistant with Derlin®, DuPONT® resin. Seamless Design on Handle.
- NSF Certified **NSF**, meet health and safety standards, Dishwasher Safe and SteriShield® Anti-Bacterial protection.
- 精选德国高级钼钒钢材X50CrMoV15精锻而成, 加上使用冰锻 (Ice Hardened) 技术处理, 令刀锋更持久锋利, 坚韧耐用。
- 技术团队经长时间精心钻研, 寻求不同用途的刀, 对刀刃角度的要求, 在锋利及耐用两方面取得平衡, 形成 —Cutlery-Pro®— 独特的刀刃加工技术, 配合以雷射角度测试仪来控制产品的质量, 保证刀具的刀刃锋利、持久耐用及锻修容易, 刀刃口不易崩缺或断裂。
- —Cutlery-Pro®— 刀具以崭新的人体工学作为设计基础蓝本, 手柄的指撑设计, 配合美国杜邦公司Delrin®注塑材料, 握感平衡舒适, 稳固不滑, 长时间使用轻松自如。手柄不会脱落。
- —Cutlery-Pro®— 刀具通过 **NSF** 美国国家卫生基金会 (National Sanitation Foundation) 认证; 配合 —Cutlery-Pro®— 专利的抗菌设计 SteriShield®, 产品的卫生安全更有保证。产品设计不留缝隙驳口, 可放入洗碗碟机清洗, 方便卫生。



Peeling Knife

雕花刀

KR-6407-65-BK301-CP-CP	2.5"(65mm)	●	24



Paring Knife

果皮刀

KR-6406-90-BK301-CP-CP	3.5"(90mm)	●	24



Steak Knife

牛扒刀

KR-6502-110-BK301-CP-CP	4.25"(110mm)	●	24



Steak Knife -Sab

牛扒刀, Sab齿

KR-6402-115SAB-BK301-CP-CP	4.5"(115mm)	●	24



Steak Knife -Round Head

牛扒刀, 圆头

KR-6402-120R-BK301-CP-CP	4.75"(120mm)	●	24



Steak Knife

牛扒刀

KR-6402-120-BK301-CP-CP	4.75"(120mm)	●	24



Utility Knife -Serrated

万用刀, 齿

KR-6405-150S-BK301-CP-CP	6"(150mm)	●	24



Carving Fork

叉

KR-6444-150-BK301-CP-CP	6"(150mm)	●	24



Carving Fork -Curved

叉, 弯

KR-6444-150C-BK301-CP-CP	6"(150mm)	●	24

Boning Knife

-Straight & Narrow Curved Blade

骨刀, 直身, 窄, 弯刃

KR-6438-150-BK301-CP-CP	6"(150mm)	●	24

Boning Knife

-Straight & Narrow Curved Blade, Semi Flex

骨刀, 直身, 窄, 弯刃, 半弹

KR-6438-150SF-BK301-CP-CP	6"(150mm)	●	24

Meat Cleaver

砍骨刀

KR-6488-150-BK301-CP-CP	6"(150mm)	●	24

Utility Knife

万用刀

KR-6405-170-BK301-CP-CP	6.5"(170mm)	●	24

Santoku Knife

-Granton

三德刀, 欧式, 圆牙

KR-6421-180G-BK301-CP-CP	7"(180mm)	●	24

Carving Knife

切肉刀

KR-6404-200-BK301-CP-CP	8"(200mm)	●	24
KR-6404-250-BK301-CP-CP	10"(250mm)	●	24

Bread Knife

面包刀

KR-6455-200-BK301-CP-CP	8"(200mm)	●	24
KR-6455-250-BK301-CP-CP	10"(250mm)	●	24

Roast Slicer Knife

-Granton

火腿刀, 圆牙

KR-6466-250G-BK301-CP-CP	10"(250mm)	●	24
KR-6466-300G-BK301-CP-CP	12"(300mm)	●	24

Cooks Knife

厨刀

KR-6401-150-BK301-CP-CP	6"(150mm)	●	24
KR-6401-200-BK301-CP-CP	8"(200mm)	●	24
KR-6401-250-BK301-CP-CP	10"(250mm)	●	24
KR-6401-300-BK301-CP-CP	12"(300mm)	●	24

Cake Knife

-Plain

蛋糕刀, 平口

KR-6456-350P-BK301-CP-CP	14"(350mm)	●	24
KR-6456-400P-BK301-CP-CP	16"(400mm)	●	24
KR-6456-450P-BK301-CP-CP	18"(450mm)	●	24

Cake Knife

-Serrated

蛋糕刀, 齿

KR-6456-350S-BK301-CP-CP	14"(350mm)	●	24
KR-6456-400S-BK301-CP-CP	16"(400mm)	●	24
KR-6456-450S-BK301-CP-CP	18"(450mm)	●	24



Cutlery-Pro®

We are professional for
THE PROFESSIONAL



- Stamped From German Molybdenum Vanadium X50CrMoV15 Steel Alloy, Ice-Hardened available.
- Skillfully Honed —Cutlery-Pro® cutting Edge, Laser Angle Tested, Enhanced Sharpness, Edge Holding & Ease of Re-Sharpener.
- Ergonomic & Classic design with Rosewood Handle. Seamless Design on Handle.
- 精选德国高级钼钒钢材 X50CrMoV15 精锻而成, 加上使用冰焠(Ice Hardened)技术处理, 令刀锋更持久锋利, 坚韧耐用。
- 技术团队经长时间精心钻研, 寻求不同用途的刀刃角度的要求, 在锋利及耐用两方面取得平衡, 形成 —Cutlery-Pro® 独特的刀刃加工技术, 配合以雷射角度测试仪来控制产品的质量, 保证刀具的刀刃锋利、持久耐用及锻修容易, 刀刃口不易崩缺或断裂。
- —Cutlery-Pro® 刀具以崭新的人体工学作为设计基础蓝本, 手柄的指撑设计, 配合黑檀木材料, 握感平衡舒适, 稳固不滑, 长时间使用轻松自如。手柄不会脱落。



Peeling Knife 雕花刀

KR-6607-65-CP-CP	2.5"(65mm)	●	24

Paring Knife 果皮刀

KR-6606-90-CP-CP	3.5"(90mm)	●	24

Boning Knife -Straight & Wide Blade 骨刀, 直身, 宽

KR-6618-150-CP-CP	6"(150mm)	●	24

Santoku Knife -Granton 三德刀, 欧式, 圆牙

KR-6621-180G-CP-CP	7"(180mm)	●	24

Carving Knife 切肉刀

KR-6604-200-CP-CP	8"(200mm)	●	24
KR-6604-250-CP-CP	10"(250mm)	●	24

Bread Knife 面包刀

KR-6655-200-CP-CP	8"(200mm)	●	24
KR-6655-250-CP-CP	10"(250mm)	●	24

Bread Knife -Wide 面包刀, 宽

KR-6655-250W-CP-CP	10"(250mm)	●	24

Roast Slicer Knife -Granton 火腿刀, 圆牙

KR-6666-250G-CP-CP	10"(250mm)	●	24

Cooks Knife -Wide 厨刀, 宽

KR-6601-170W-CP-CP	6.75"(170mm)	●	24
KR-6601-200W-CP-CP	8"(200mm)	●	24
KR-6601-230W-CP-CP	9"(230mm)	●	24
KR-6601-260W-CP-CP	10.25"(260mm)	●	24
KR-6601-300W-CP-CP	12"(300mm)	●	24

Cake Knife -Plain 蛋糕刀, 平口

KR-6656-350P-CP-CP	14"(350mm)	●	24
KR-6656-400P-CP-CP	16"(400mm)	●	24
KR-6656-450P-CP-CP	18"(450mm)	●	24

Cake Knife -Serrated 蛋糕刀, 齿



KR-6656-350S-CP-CP	14"(350mm)	●	24
KR-6656-400S-CP-CP	16"(400mm)	●	24
KR-6656-450S-CP-CP	18"(450mm)	●	24





PRO-GRIP

HACCP, 西厨系列

- Stamped From German Molybdenum Vanadium X50CrMoV15 Steel Alloy ,Ice-Hardened available.
- Skillfully Honed —Cutlery-Pro® cutting Edge, Laser Angle Tested ,Enhanced Sharpness, Edge Holding & Ease of Re-Sharpener.
- Ergonomic, Slip Resistant with Santoprene® (PRO-GRIP) or Polypropylene(PRO-LINE) resin . Seamless Design on Handle.
- Color Coding system available , Comply with HACCP regulation.
- NSF Certified  , meet health and safety standards, Dishwasher Safe and SteriShield® Anti-Bacterial protection.
- 精选德国高级钼钒钢材X50CrMoV15精锻而成, 加上使用冰锻(Ice Hardened)技术处理, 令刀锋更持久锋利, 坚韧耐用。
- 技术团队经长时间精心钻研, 寻求不同用途的刀, 对刀刃角度的要求, 在锋利及耐用两方面取得平衡, 形成—Cutlery-Pro®—独特的刀刃加工技术, 配合以雷射角度测试仪来控制产品的质量, 保证刀具的刀刃锋利、持久耐用及锻修容易, 刀刃口不易崩缺或断裂。
- 刀具以崭新的人体工学作为设计基础蓝本, 手柄的指撑设计, 配合美国Santoprene®橡胶或Polypropylene 注塑材料, 握感平衡舒适, 稳固不滑, 长时间使用轻松自如。手柄不会脱落。
- 建立手柄颜色系统符合HACCP食品安全控制体系标准, 防止细菌交叉感染, 产品设计不留缝隙驳口, 可放入洗碗碟机清洗, 方便卫生。
- 刀具通过  美国国家卫生基金会(National Sanitation Foundation)认证; 配合—Cutlery-Pro®—专利的抗菌设计SteriShield®, 产品的卫生安全更有保证。

HACCP Color Coding

HACCP系列
颜色分类说明



DAIRY
糕点及
乳制品类



RAW MEAT
红肉类



SEAFOOD
海鲜类



COOKED
FOOD
熟食类



VEGETABLE
蔬果类



POULTRY
家禽类



ALLERGEN
SAFE
过敏原类

Peeling Knife

雕花刀

Shopping Cart	mm	Color Coding	Box
KB-07-65YD-BK101-CP-CP	2.5"(65mm)		288
KB-07-70YD-BK101-CP-CP	2.75"(70mm)		288



Peeling Knife

-Narrow

雕花刀, 窄

Shopping Cart	mm	Color Coding	Box
KB-07-70NYD-BK101-CP-CP	2.75"(70mm)		288
KB-07-80NYD-BK101-CP-CP	3.25"(80mm)		288



Paring Knife

-European

果皮刀, 欧式

Shopping Cart	mm	Color Coding	Box
KB-06-80EUYD-BK101-CP-CP	3"(80mm)		288



Paring Knife

果皮刀

Shopping Cart	mm	Color Coding	Box
KB-06-80YD-BK101-CP-CP	3"(80mm)		288
KB-06-90YD-BK101-CP-CP	3.5"(90mm)		288



Paring Knife

-Serrated

果皮刀, 齿

Shopping Cart	mm	Color Coding	Box
KB-06-80SYD-BK101-CP-CP	3"(80mm)		288
KB-06-90SYD-BK101-CP-CP	3.5"(90mm)		288



Paring Knife

-Narrow

果皮刀, 窄

Shopping Cart	mm	Color Coding	Box
KB-06-65NYD-BK101-CP-CP	2.5"(65mm)		288
KB-06-80NYD-BK101-CP-CP	3.25"(80mm)		288



24 Pcs Set
24 件装



24 Pcs Set
24 件装



24 Pcs Set
24 件装



Paring Knife

果皮刀

KB-06-100YD-BK101-CP-CP	4"(100mm)		288



**Paring Knife
-Serrated**

果皮刀, 齿

KB-06-100SYD-BK101-CP-CP	4"(100mm)		288



**Utility Knife
-Serrated**

万用刀, 齿

KB-05-100SYD-BK101-CP-CP	4"(100mm)		288



Steak Knife

牛扒刀

KB-02-110YD-BK101-CP-CP	4.25"(110mm)		288



Tomato Knife

番茄刀

KB-09-110YD-BK101-CP-CP	4.25"(110mm)		288



Table Spoon

餐勺

GS-303-03-BK101-CP-CP	4"(100mm)		288



Table Fork

餐叉

GS-303-02-BK101-CP-CP	4"(100mm)		288



Peeling Knife

雕花刀

KB-3807-65-BK201-CP-CP	2.5"(65mm)		48



Paring Knife

果皮刀

KB-3806-90-BK201-CP-CP	3.5"(90mm)		48
KB-3806-100-BK201-CP-CP	4"(100mm)		48



**Paring Knife
-Serrated**

果皮刀, 齿

KB-3806-90S-BK201-CP-CP	3.5"(90mm)		48
KB-3806-100S-BK201-CP-CP	4"(100mm)		48



Utility Knife

万用刀

KB-3805-150-BK201-CP-CP	6"(150mm)		48



**Utility Knife
-Semi Flex**

万用刀, 半弹

KB-3805-150SF-BK201-CP-CP	6"(150mm)		48



**Utility Knife
-Serrated**

万用刀, 齿

KB-3805-130S-BK201-CP-CP	5"(130mm)		48

Skinning,Beef Knife
-European

牛皮刀, 欧式

Shopping Cart	mm	Color	Box
KB-3849-150-BK201-CP-CP	6"(150mm)	●●	48
KB-3849-180-BK201-CP-CP	7"(180mm)	●●	48

Skinning,Lamb Knife

羊皮刀

Shopping Cart	mm	Color	Box
KB-3810-130-BK201-CP-CP	5"(130mm)	●●	48
KB-3810-150-BK201-CP-CP	6"(150mm)	●●	48

Boning Knife

-Straight & Narrow Blade,A Shape

骨刀, 直身, 超窄, A形刀

Shopping Cart	mm	Color	Box
KB-3808-150A-BK201-CP-CP	6"(150mm)	●●●●	48

Boning Knife

-Straight & Narrow Blade,A Shape,Semi Flex

骨刀, 直身, 超窄, A形刀, 半弹

Shopping Cart	mm	Color	Box
KB-3808-150ASF-BK201-CP-CP	6"(150mm)	●●●●	48

Boning Knife

-Straight & Narrow Blade

骨刀, 直身, 超窄

Shopping Cart	mm	Color	Box
KB-3808-200-BK201-CP-CP	8"(200mm)	●●●●	48

Boning Knife

-Straight & Wide Blade

骨刀, 直身, 宽

Shopping Cart	mm	Color	Box
KB-3818-130-BK201-CP-CP	5"(130mm)	●●●●	48
KB-3818-150-BK201-CP-CP	6"(150mm)	●●●●	48

Boning Knife

-Straight & Narrow Curved Blade

骨刀, 直身, 窄, 弯刃

Shopping Cart	mm	Color	Box
KB-3838-130-BK201-CP-CP	5"(130mm)	●●●●	48
KB-3838-150-BK201-CP-CP	6"(150mm)	●●●●	48

Boning Knife

-Straight & Narrow Curved Blade,Semi Flex

骨刀, 直身, 窄, 弯刃, 半弹

Shopping Cart	mm	Color	Box
KB-3838-130SF-BK201-CP-CP	5"(130mm)	●●●●	48
KB-3838-150SF-BK201-CP-CP	6"(150mm)	●●●●	48

Boning Knife

-Narrow Curved Blade

骨刀, 窄, 弯刃

Shopping Cart	mm	Color	Box
KB-3858-130-BK201-CP-CP	5"(130mm)	●●●●	48
KB-3858-150-BK201-CP-CP	6"(150mm)	●●●●	48

Boning Knife

-Narrow Curved Blade,Semi Flex

骨刀, 窄, 弯刃, 半弹

Shopping Cart	mm	Color	Box
KB-3858-130SF-BK201-CP-CP	5"(130mm)	●●●●	48
KB-3858-150SF-BK201-CP-CP	6"(150mm)	●●●●	48

Sticking Knife

骨刀

Shopping Cart	mm	Color	Box
KB-3868-180-BK201-CP-CP	7"(180mm)	●●●●	48
KB-3868-200-BK201-CP-CP	8"(200mm)	●●●●	48
KB-3868-230-BK201-CP-CP	9"(230mm)	●●●●	48
KB-3868-250-BK201-CP-CP	10"(250mm)	●●●●	48

Pointed Tips

骨刀

Shopping Cart	mm	Color	Box
KB-3878-130-BK201-CP-CP	5"(130mm)	●●●●	48
KB-3878-150-BK201-CP-CP	6"(150mm)	●●●●	48
KB-3878-180-BK201-CP-CP	7"(180mm)	●●●●	48
KB-3878-200-BK201-CP-CP	8"(200mm)	●●●●	48





Bread Knife

面包刀

Shopping Cart	mm	Color	Box
KB-3855-200-BK201-CP-CP	8"(200mm)	●●	48
KB-3855-250-BK201-CP-CP	10"(250mm)	●●	48
KB-3855-300-BK201-CP-CP	12"(300mm)	●●	48



Bread Knife
-Offset

面包刀, 曲

Shopping Cart	mm	Color	Box
KB-3855-230FS-BK201-CP-CP	9"(230mm)	●●	48



Bread Knife
-Curved

面包刀, 弯

Shopping Cart	mm	Color	Box
KB-3855-250C-BK201-CP-CP	10"(250mm)	●●	48



Bread Knife
-Wide

面包刀, 宽

Shopping Cart	mm	Color	Box
KB-3855-250W-BK201-CP-CP	10"(250mm)	●●	48



Santoku Knife
-Granton

三德刀, 欧式, 圆牙

Shopping Cart	mm	Color	Box
KB-3821-180G-BK201-CP-CP	7"(180mm)	●●●●	48



Utility Slicer Knife
-Serrated

切肉刀, 齿

Shopping Cart	mm	Color	Box
KB-3804-230S-BK201-CP-CP	9"(230mm)	●●●●	48



Carving Knife

切肉刀

Shopping Cart	mm	Color	Box
KB-3804-150-BK201-CP-CP	6"(150mm)	●●●●	48
KB-3804-200-BK201-CP-CP	8"(200mm)	●●●●	48
KB-3804-250-BK201-CP-CP	10"(250mm)	●●●●	48
KB-3804-300-BK201-CP-CP	12"(300mm)	●●●●	48



Meat Cleaver

砍骨刀

Shopping Cart	mm	Color	Box
KB-2288-150-BK101-CP-CP	6"(150mm)	●●●●	24
KB-2288-180-BK101-CP-CP	7"(180mm)	●●●●	24
KB-2288-200-BK101-CP-CP	8"(200mm)	●●●●	24
KB-2288-230-BK101-CP-CP	9"(230mm)	●●●●	24



Breaking Knife

开锋刀

Shopping Cart	mm	Color	Box
KB-3812-200-BK201-CP-CP	8"(200mm)	●●	48
KB-3812-250-BK201-CP-CP	10"(250mm)	●●	48



Cimeter Knife

大弯刀

Shopping Cart	mm	Color	Box
KB-3819-250-BK201-CP-CP	10"(250mm)	●●	48
KB-3819-300-BK201-CP-CP	12"(300mm)	●●	48



Salmon Knife
-Granton







三文鱼刀, 圆牙

Shopping Cart	mm	Color	Box
KB-3852-300G-BK201-CP-CP	12"(300mm)	●●	48

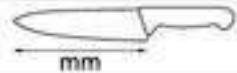
Roast Slicer Knife

-Plain







火腿刀, 平口

			
	mm		
KB-3866-250P-BK201-CP-CP	10"(250mm)		48
KB-3866-300P-BK201-CP-CP	12"(300mm)		48
KB-3866-350P-BK201-CP-CP	14"(350mm)		48
KB-3866-450P-BK201-CP-CP	18"(450mm)		48

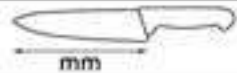
Roast Slicer Knife

-Serrated





火腿刀, 齿

			
	mm		
KB-3866-250S-BK201-CP-CP	10"(250mm)		48
KB-3866-300S-BK201-CP-CP	12"(300mm)		48
KB-3866-350S-BK201-CP-CP	14"(350mm)		48
KB-3866-450S-BK201-CP-CP	18"(450mm)		48

Roast Slicer Knife

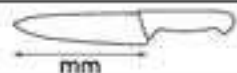



-Granton

火腿刀, 圆牙

			
	mm		
KB-3866-250G-BK201-CP-CP	10"(250mm)		48
KB-3866-300G-BK201-CP-CP	12"(300mm)		48

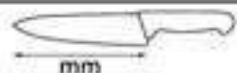
Butcher Knife







牛肉刀

			
	mm		
KB-3803-250-BK201-CP-CP	10"(250mm)		48
KB-3803-300-BK201-CP-CP	12"(300mm)		48

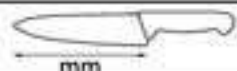
Wide Butcher Knife









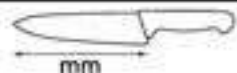

-European

直身牛肉刀, 欧式

			
	mm		
KB-3853-180EU-BK201-CP-CP	7"(180mm)		48
KB-3853-200EU-BK201-CP-CP	8"(200mm)		48
KB-3853-250EU-BK201-CP-CP	10"(250mm)		48
KB-3853-300EU-BK201-CP-CP	12"(300mm)		48











Straight Butcher Knife

直身牛肉刀

			
	mm		
KB-3843-150-BK201-CP-CP	6"(150mm)		48
KB-3843-180-BK201-CP-CP	7"(180mm)		48
KB-3843-200-BK201-CP-CP	8"(200mm)		48
KB-3843-230-BK201-CP-CP	9"(230mm)		48
KB-3843-250-BK201-CP-CP	10"(250mm)		48
KB-3843-280-BK201-CP-CP	11"(280mm)		48
KB-3843-300-BK201-CP-CP	12"(300mm)		48

Cooks Knife







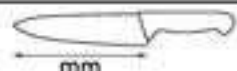

厨刀

			
	mm		
KB-3801-150-BK201-CP-CP	6"(150mm)		48
KB-3801-160-BK201-CP-CP	6.25"(160mm)		48
KB-3801-190-BK201-CP-CP	7.5"(190mm)		48
KB-3801-200-BK201-CP-CP	8"(200mm)		48
KB-3801-250-BK201-CP-CP	10"(250mm)		48
KB-3801-300-BK201-CP-CP	12"(300mm)		48

Cooks Knife

-Wide







厨刀, 宽

			
	mm		
KB-3801-170W-BK201-CP-CP	6.75"(170mm)		48
KB-3801-200W-BK201-CP-CP	8"(200mm)		48
KB-3801-230W-BK201-CP-CP	9"(230mm)		48
KB-3801-260W-BK201-CP-CP	10.25"(260mm)		48
KB-3801-300W-BK201-CP-CP	12"(300mm)		48

Cake Knife

-Plain







蛋糕刀, 平口

			
	mm		
KB-3856-350P-BK301-CP-CP	14"(350mm)		48
KB-3856-400P-BK301-CP-CP	16"(400mm)		48
KB-3856-450P-BK301-CP-CP	18"(450mm)		48

Cake Knife

-Serrated

蛋糕刀, 齿

			
	mm		
KB-3856-350S-BK301-CP-CP	14"(350mm)		48
KB-3856-400S-BK301-CP-CP	16"(400mm)		48
KB-3856-450S-BK301-CP-CP	18"(450mm)		48



Cutlery-Pro®

We are professional for
THE PROFESSIONAL

*Professional Knives
For Food Processing*

Cutlery-Pro®

We are professional for
THE PROFESSIONAL



Cutlery-Pro®

QINGSHANLI®

- Stamped From German Molybdenum Vanadium X50CrMoV15 Steel Alloy ,Ice-Hardened available.
- Skillfully Honed —Cutlery-Pro®— cutting Edge, Laser Angle Tested , Enhanced Sharpness, Edge Holding & Ease of Re-Sharping.
- Ergonomic, Slip Resistant with PRO-TEX design . Seamless Design on Handle.
- NSF Certified  , meet health and safety standards, Dishwasher Safe and SteriShield® Anti-Bacterial protection.
- 精选德国高级钼钒钢材X50CrMoV15精锻而成, 加上使用冰锻(Ice Hardened)技术处理, 令刀锋更持久锋利, 坚韧耐用。
- 技术团队经长时间精心钻研, 寻求不同用途的刀, 对刀刃角度的要求, 在锋利及耐用两方面取得平衡, 形成—Cutlery-Pro®—独特的刀刃加工技术, 配合以雷射角度测试仪来控制产品的质量, 保证刀具的刀刃锋利、持久耐用及锻修容易, 刀刃口不易崩缺或断裂。
- 刀具以崭新的人体工学作为设计基础蓝本, 手柄的指撑设计, 配合PRO-TEX独特设计, 握感平衡舒适, 稳固不滑, 长时间使用轻松自如。手柄不会脱落。
- 建立手柄颜色系统符合HACCP食品安全控制体系标准, 防止细菌交叉感染, 产品设计不留缝隙驳口, 可放入洗碗碟机清洗, 方便卫生。
- 刀具通过  美国国家卫生基金会(National Sanitation Foundation)认证; 配合—Cutlery-Pro®—专利的抗菌设计SteriShield®, 产品的卫生安全更有保证。

Paring Knife

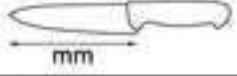
果皮刀



			
KB-06-80YD-OR103-CP-CP	3"(80mm)	●	288
KB-06-90YD-OR103-CP-CP	3.5"(90mm)	●	288



Utility Knife

-Serrated

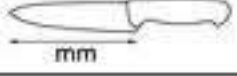
万用刀, 齿



			
KB-05-100SYD-OR103-CP-CP	4"(100mm)	●	288



Skinning,Beef Knife

-European

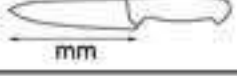

牛皮刀, 欧式

			
KB-7349-150-OR103-CP-CP	6"(150mm)	●	48
KB-7349-180-OR103-CP-CP	7"(180mm)	●	48

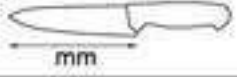

Skinning,Lamb Knife

羊皮刀



			
KB-7310-130-OR103-CP-CP	5"(130mm)	●	48
KB-7310-150-OR103-CP-CP	6"(150mm)	●	48



Boning Knife

-Straight & Narrow Blade,A Shape

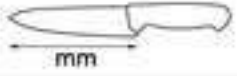
骨刀, 直身, 超窄, A形刀



			
KB-7308-150A-OR103-CP-CP	6"(150mm)	●	48



Boning Knife

-Straight & Narrow Blade,A Shape,Semi Flex

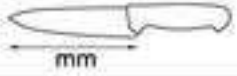
骨刀, 直身, 超窄, A形刀, 半弹



			
KB-7308-150ASF-OR103-CP-CP	6"(150mm)	●	48



Boning Knife

-Straight & Wide Blade

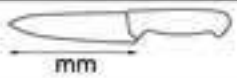
骨刀, 直身, 宽

			
KB-7318-130-OR103-CP-CP	5"(130mm)	●	48
KB-7318-150-OR103-CP-CP	6"(150mm)	●	48





Boning Knife

-Straight & Narrow Curved Blade

骨刀, 直身, 窄, 弯刃

	mm		
KB-7338-130-OR103-CP-CP	5"(130mm)	●	48
KB-7338-150-OR103-CP-CP	6"(150mm)	●	48



Boning Knife

-Straight & Narrow Curved Blade, Semi Flex

骨刀, 直身, 窄, 弯刃, 半弹

	mm		
KB-7338-130SF-OR103-CP-CP	5"(130mm)	●	48
KB-7338-150SF-OR103-CP-CP	6"(150mm)	●	48



Boning Knife

-Narrow Curved Blade

骨刀, 窄, 弯刃

	mm		
KB-7358-130-OR103-CP-CP	5"(130mm)	●	48
KB-7358-150-OR103-CP-CP	6"(150mm)	●	48



Boning Knife

-Wide

骨刀, 宽

	mm		
KB-7348-150-OR103-CP-CP	6"(150mm)	●	48



Boning Knife

-Narrow Curved Blade, Semi Flex

骨刀, 窄, 弯刃, 半弹

	mm		
KB-7358-130SF-OR103-CP-CP	5"(130mm)	●	48
KB-7358-150SF-OR103-CP-CP	6"(150mm)	●	48



Boning Knife

-Narrow Curved Blade, Semi Flex, Granton

骨刀, 窄, 弯刃, 半弹, 圆牙

	mm		
KB-7358-150SFG-OR103-CP-CP	6"(150mm)	●	48



Boning Knife

-Straight & Narrow Blade

骨刀, 直身, 超窄

	mm		
KB-7308-200-OR103-CP-CP	8"(200mm)	●	48



Pointed Tips

骨刀

	mm		
KB-7378-130-OR103-CP-CP	5"(130mm)	●	48
KB-7378-150-OR103-CP-CP	6"(150mm)	●	48
KB-7378-180-OR103-CP-CP	7"(180mm)	●	48
KB-7378-200-OR103-CP-CP	8"(200mm)	●	48



Sticking Knife



骨刀

	mm		
KB-7368-180-OR103-CP-CP	7"(180mm)	●	48
KB-7368-200-OR103-CP-CP	8"(200mm)	●	48
KB-7368-230-OR103-CP-CP	9"(230mm)	●	48
KB-7368-250-OR103-CP-CP	10"(250mm)	●	48

Santoku Knife

-Granton

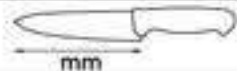
三德刀, 欧式, 圆牙



			
KB-7321-180G-OR103-CP-CP	7"(180mm)	●	48



Cooks Knife

-Wide

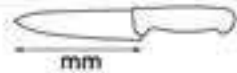

厨刀, 宽

			
KB-7301-170W-OR103-CP-CP	6.75"(170mm)	●	48
KB-7301-200W-OR103-CP-CP	8"(200mm)	●	48
KB-7301-230W-OR103-CP-CP	9"(230mm)	●	48
KB-7301-260W-OR103-CP-CP	10.25"(260mm)	●	48
KB-7301-300W-OR103-CP-CP	12"(300mm)	●	48



Straight Butcher Knife

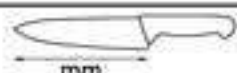

直身牛肉刀

			
KB-3843-150-BK201-CP-CP	6"(150mm)	●	48
KB-3843-180-BK201-CP-CP	7"(180mm)	●	48
KB-3843-200-BK201-CP-CP	8"(200mm)	●	48
KB-3843-230-BK201-CP-CP	9"(230mm)	●	48
KB-3843-250-BK201-CP-CP	10"(250mm)	●	48
KB-3843-280-BK201-CP-CP	11"(280mm)	●	48
KB-3843-300-BK201-CP-CP	12"(300mm)	●	48

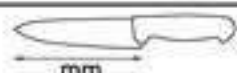

Butcher Knife

牛肉刀





			
KB-7303-250-OR103-CP-CP	10"(250mm)	●	48
KB-7303-300-OR103-CP-CP	12"(300mm)	●	48



Wide Butcher Knife

-European

直身牛肉刀, 欧式





			
KB-7353-180EU-OR103-CP-CP	7"(180mm)	●	48
KB-7353-200EU-OR103-CP-CP	8"(200mm)	●	48
KB-7353-250EU-OR103-CP-CP	10"(250mm)	●	48
KB-7353-300EU-OR103-CP-CP	12"(300mm)	●	48



Roast Slicer Knife

-Serrated

火腿刀, 齿





			
KB-7366-300S-OR103-CP-CP	12"(300mm)	●	48



Cimeter Knife

-Granton



大弯刀, 圆牙

			
KB-7319-250G-OR103-CP-CP	10"(250mm)	●	48



Breaking Knife

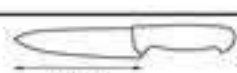



开锋刀

			
KB-7312-200-OR103-CP-CP	8"(200mm)	●	48
KB-7312-250-OR103-CP-CP	10"(250mm)	●	48



Cimeter Knife

大弯刀

			
KB-7319-250-OR103-CP-CP	10"(250mm)	●	48
KB-7319-300-OR103-CP-CP	12"(300mm)	●	48



- Stamped From German Molybdenum Vanadium X50CrMoV15 Steel Alloy ,Ice-Hardened available.
- Skillfully Honed —Cutlery-Pro® cutting Edge, Laser Angle Tested ,Enhanced Sharpness, Edge Holding & Ease of Re-Sharping. Ergonomic, Slip Resistant with Santoprene® resin .Seamless Design on Handle.
- Color Coding system available , Comply with HACCP regulation.
- NSF Certified **NSF** , meet health and safety standards, Dishwasher Safe and SteriShield® Anti-Bacterial protection.
- 精选德国高级钼钒钢材X50CrMoV15精锻而成, 加上使用冰锻(Ice Hardened)技术处理, 令刀锋更持久锋利, 坚韧耐用。
- 技术团队经长时间精心钻研, 寻求不同用途的刀, 对刀刃角度的要求, 在锋利及耐用两方面取得平衡, 形成—Cutlery-Pro®—独特的刀刃加工技术, 配合以雷射角度测试仪来控制产品的质量, 保证刀具的刀刃锋利、持久耐用及锻修容易, 刀刃口不易崩缺或断裂。
- 刀具以崭新的人体工学作为设计基础蓝本, 手柄的指撑设计, 配合美国杜邦公司Santoprene®橡胶注塑材料, 握感平衡舒适, 稳固不滑, 长时间使用轻松自如。手柄不会脱落。
- 建立手柄颜色系统符合HACCP食品安全控制体系标准, 防止细菌交叉感染, 产品设计不留缝隙驳口, 可放入洗碗碟机清洗, 方便卫生。
- 刀具通过 **NSF** 美国国家卫生基金会(National Sanitation Foundation)认证; 配合—Cutlery-Pro®—专利的抗菌设计SteriShield®, 产品的卫生安全更有保证。

HACCP Color Coding
HACCP系列颜色分类说明

 DAIRY
糕点及乳制品类

 RAW MEAT
红肉类

 SEAFOOD
海鲜类

 COOKED FOOD
熟食类

 VEGETABLE
蔬果类





 POULTRY
家禽类

 ALLERGEN SAFE
过敏原类



Paring Knife





果皮刀

			
KB-1806-90-GY201-CP-CP	3.5"(90mm)		48

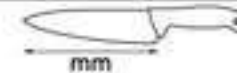

Utility Knife
-Serrated





万用刀, 齿

			
KB-1805-130S-GY201-CP-CP	5"(130mm)		48

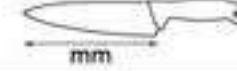

Skinning, Lamb Knife







羊皮刀

			
KB-1810-130-GY201-CP-CP	5"(130mm)		48
KB-1810-150-GY201-CP-CP	6"(150mm)		48



Skinning, Beef Knife
-European



牛皮刀, 欧式

			
KB-1849-150-GY201-CP-CP	6"(150mm)		48
KB-1849-180-GY201-CP-CP	7"(180mm)		48



Skinning, Beef Knife









牛皮刀

			
KB-1813-120-GY201-CP-CP	4.75"(120mm)		48
KB-1813-150-GY201-CP-CP	6"(150mm)		48



Carving Knife





切肉刀

			
KB-1804-150-GY201-CP-CP	6"(150mm)		48
KB-1804-200-GY201-CP-CP	8"(200mm)		48
KB-1804-250-GY201-CP-CP	10"(250mm)		48
KB-1804-300-GY201-CP-CP	12"(350mm)		48

Boning Knife

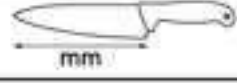
-Straight & Extra Narrow Blade





骨刀, 直身, 超窄

			
KB-1808-150-GY201-CP-CP	6"(150mm)		48
KB-1808-200-GY201-CP-CP	8"(200mm)		48

Boning Knife

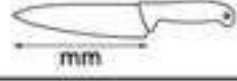
-Straight & Narrow Blade, Semi Flex





骨刀, 直身, 超窄, 半弹

			
KB-1808-150SF-GY201-CP-CP	6"(150mm)		48

Boning Knife

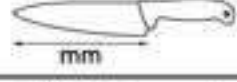
-Straight & Wide Blade





骨刀, 直身, 宽

			
KB-1818-130-GY201-CP-CP	5"(130mm)		48
KB-1818-150-GY201-CP-CP	6"(150mm)		48

Boning Knife

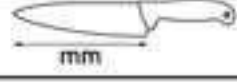
-Straight & Narrow Blade







骨刀, 直身, 窄

			
KB-1828-150-GY201-CP-CP	6"(150mm)		48

Boning Knife

-Straight & Narrow Curved Blade





骨刀, 直身, 窄, 弯刃

			
KB-1838-130-GY201-CP-CP	5"(130mm)		48
KB-1838-150-GY201-CP-CP	6"(150mm)		48

Boning Knife

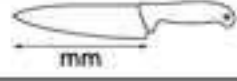
-Straight & Narrow Curved Blade, Semi Flex





骨刀, 直身, 窄, 弯刃, 半弹

			
KB-1838-130SF-GY201-CP-CP	5"(130mm)		48
KB-1838-150SF-GY201-CP-CP	6"(150mm)		48

Boning Knife

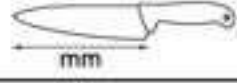
-Wide, Curved Blade





骨刀, 宽, 弯刃

			
KB-1848-150-GY201-CP-CP	6"(150mm)		48

Boning Knife

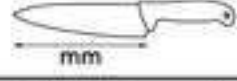
-Narrow, Curved Blade





骨刀, 窄, 弯刃

			
KB-1858-130-GY201-CP-CP	5"(130mm)		48
KB-1858-150-GY201-CP-CP	6"(150mm)		48

Boning Knife

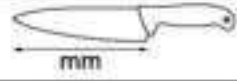
-Narrow, Curved Blade, Semi Flex





骨刀, 窄, 弯刃, 半弹

			
KB-1858-130SF-GY201-CP-CP	5"(130mm)		48
KB-1858-150SF-GY201-CP-CP	6"(150mm)		48

Boning Knife

-Straight & Wide Curved Blade

骨刀, 直身, 宽, 弯刃

			
KB-1898-130-GY201-CP-CP	5"(130mm)		48
KB-1898-150-GY201-CP-CP	6"(150mm)		48





Pointed Tips

Shopping Cart	mm	Color	Box
KB-1878-130-GY201-CP-CP	5"(130mm)	Colorful	48
KB-1878-150-GY201-CP-CP	6"(150mm)	Colorful	48
KB-1878-180-GY201-CP-CP	7"(180mm)	Colorful	48
KB-1878-200-GY201-CP-CP	8"(200mm)	Colorful	48

Sticking Knife

Shopping Cart	mm	Color	Box
KB-1868-180-GY201-CP-CP	7"(180mm)	Colorful	48
KB-1868-200-GY201-CP-CP	8"(200mm)	Colorful	48
KB-1868-230-GY201-CP-CP	9"(230mm)	Colorful	48
KB-1868-250-GY201-CP-CP	10"(250mm)	Colorful	48

Santoku Knife

Shopping Cart	mm	Color	Box
KB-1821-180G-GY201-CP-CP	7"(180mm)	Colorful	48

Bread Knife

Shopping Cart	mm	Color	Box
KB-1855-200-GY201-CP-CP	8"(200mm)	Colorful	48
KB-1855-250-GY201-CP-CP	10"(250mm)	Colorful	48
KB-1855-300-GY201-CP-CP	12"(300mm)	Colorful	48

Bread Knife

Shopping Cart	mm	Color	Box
KB-1855-230FS-GY201-CP-CP	9"(230mm)	Colorful	48

Bread Knife

Shopping Cart	mm	Color	Box
KB-1855-250C-GY201-CP-CP	10"(250mm)	Colorful	48

Bread Knife

Shopping Cart	mm	Color	Box
KB-1855-250W-GY201-CP-CP	10"(250mm)	Colorful	48

Roast Slicer Knife

Shopping Cart	mm	Color	Box
KB-1866-250P-GY201-CP-CP	10"(250mm)	Colorful	48
KB-1866-300P-GY201-CP-CP	12"(300mm)	Colorful	48
KB-1866-350P-GY201-CP-CP	14"(350mm)	Colorful	48
KB-1866-450P-GY201-CP-CP	18"(450mm)	Colorful	48

Roast Slicer Knife

Shopping Cart	mm	Color	Box
KB-1866-250S-GY201-CP-CP	10"(250mm)	Colorful	48
KB-1866-300S-GY201-CP-CP	12"(300mm)	Colorful	48
KB-1866-350S-GY201-CP-CP	14"(350mm)	Colorful	48
KB-1866-450S-GY201-CP-CP	18"(450mm)	Colorful	48

Roast Slicer Knife

Shopping Cart	mm	Color	Box
KB-1866-250G-GY201-CP-CP	10"(250mm)	Colorful	48
KB-1866-300G-GY201-CP-CP	12"(300mm)	Colorful	48
KB-1866-350G-GY201-CP-CP	14"(350mm)	Colorful	48
KB-1866-450G-GY201-CP-CP	18"(450mm)	Colorful	48

Salmon Knife

-Granton

三文鱼刀, 圆牙

Shopping Cart	mm	Color	Box
KB-1852-300G-GY201-CP-CP	12"(300mm)	Green, Yellow, Blue, Purple	48

Breaking Knife

开锋刀

Shopping Cart	mm	Color	Box
KB-1812-200-GY201-CP-CP	8"(200mm)	Green, Yellow, Blue, Purple	48
KB-1812-250-GY201-CP-CP	10"(250mm)	Green, Yellow, Blue, Purple	48

Cimeter Knife

大弯刀

Shopping Cart	mm	Color	Box
KB-1819-250W-GY201-CP-CP	10"(250mm)	Green, Yellow, Blue, Purple	48
KB-1819-300W-GY201-CP-CP	12"(300mm)	Green, Yellow, Blue, Purple	48

Butcher Knife

牛肉刀

Shopping Cart	mm	Color	Box
KB-1803-250-GY201-CP-CP	10"(250mm)	Green, Yellow, Blue, Purple	48
KB-1803-300-GY201-CP-CP	12"(300mm)	Green, Yellow, Blue, Purple	48

Wide Butcher Knife

-European

直身牛肉刀, 欧式

Shopping Cart	mm	Color	Box
KB-1853-180EU-GY201-CP-CP	7"(180mm)	Green, Yellow, Blue, Purple	48
KB-1853-200EU-GY201-CP-CP	8"(200mm)	Green, Yellow, Blue, Purple	48
KB-1853-250EU-GY201-CP-CP	10"(250mm)	Green, Yellow, Blue, Purple	48
KB-1853-300EU-GY201-CP-CP	12"(300mm)	Green, Yellow, Blue, Purple	48

Straight Butcher Knife

直身牛肉刀

Shopping Cart	mm	Color	Box
KB-1843-150-GY201-CP-CP	6"(150mm)	Green, Yellow, Blue, Purple	48
KB-1843-180-GY201-CP-CP	7"(180mm)	Green, Yellow, Blue, Purple	48
KB-1843-200-GY201-CP-CP	8"(200mm)	Green, Yellow, Blue, Purple	48

Straight Butcher Knife

直身牛肉刀

Shopping Cart	mm	Color	Box
KB-1843-230-GY201-CP-CP	9"(230mm)	Green, Yellow, Blue, Purple	48
KB-1843-250-GY201-CP-CP	10"(250mm)	Green, Yellow, Blue, Purple	48

Straight Butcher Knife

直身牛肉刀

Shopping Cart	mm	Color	Box
KB-1843-280-GY201-CP-CP	11"(280mm)	Green, Yellow, Blue, Purple	48
KB-1843-300-GY201-CP-CP	12"(300mm)	Green, Yellow, Blue, Purple	48

Cooks Knife

厨刀

Shopping Cart	mm	Color	Box
KB-1801-150-GY201-CP-CP	6"(150mm)	Green, Yellow, Blue, Purple	48
KB-1801-200-GY201-CP-CP	8"(200mm)	Green, Yellow, Blue, Purple	48

Cooks Knife

厨刀

Shopping Cart	mm	Color	Box
KB-1801-250-GY201-CP-CP	10"(250mm)	Green, Yellow, Blue, Purple	48
KB-1801-300-GY201-CP-CP	12"(300mm)	Green, Yellow, Blue, Purple	48

Cooks Knife

-Wide

厨刀, 宽

Shopping Cart	mm	Color	Box
KB-1801-170W-GY201-CP-CP	6.75"(170mm)	Green, Yellow, Blue, Purple	48
KB-1801-200W-GY201-CP-CP	8"(200mm)	Green, Yellow, Blue, Purple	48
KB-1801-230W-GY201-CP-CP	9"(230mm)	Green, Yellow, Blue, Purple	48
KB-1801-260W-GY201-CP-CP	10.25"(260mm)	Green, Yellow, Blue, Purple	48
KB-1801-300W-GY201-CP-CP	12"(300mm)	Green, Yellow, Blue, Purple	48



Cutlery-Pro®
We are professional for
THE PROFESSIONAL

Cutlery-Pro®
We are professional for
THE PROFESSIONAL

Cutlery-Pro®
High Carbon German Steel
A50C46V15 NSF
134230

CHINESE KNIVES



HACCP Color
Coding



DAIRY
糕点及
乳制品类

RAW MEAT
红肉类

SEAFOOD
海鲜类

COOKED
FOOD
熟食类

VEGETABLE
蔬果类

ALLERGEN
SAFE
过敏原类







- Stamped From German Molybdenum Vanadium X50CrMoV15 Steel Alloy ,Ice-Hardened available.
- Skillfully Honed —Cutlery-Pro®— cutting Edge, Laser Angle Tested ,Enhanced Sharpness, Edge Holding & Ease of Re-Sharpening. Ergonomic, Slip Resistant with Santoprene® resin .Seamless Design on Handle.
- Color Coding system available , Comply with HACCP regulation.
- NSF Certified  , meet health and safety standards, Dishwasher Safe and SteriShield® Anti-Bacterial protection.
- 精选德国高级钼钒钢材X50CrMoV15精锻而成, 加上使用冰锻(Ice Hardened)技术处理, 令刀锋更持久锋利, 坚韧耐用。
- 技术团队经长时间精心钻研, 寻求不同用途的刀, 对刀刃角度的要求, 在锋利及耐用两方面取得平衡, 形成—Cutlery-Pro®—独特的刀刃加工技术, 配合以雷射角度测试仪来控制产品的质量, 保证刀具的刀刃锋利、持久耐用及锻修容易, 刀刃口不易崩缺或断裂。
- 刀具以崭新的人体工学作为设计基础蓝本, 手柄的指撑设计, 配合美国杜邦公司Santoprene®橡胶注塑材料, 握感平衡舒适, 稳固不滑, 长时间使用轻松自如。手柄不会脱落。
- 建立手柄颜色系统符合HACCP食品安全控制体系标准, 防止细菌交叉感染, 产品设计不留缝隙驳口, 可放入洗碗碟机清洗, 方便卫生。
- 刀具通过  美国国家卫生基金会(National Sanitation Foundation)认证; 配合—Cutlery-Pro®—专利的抗菌设计SteriShield®, 产品的卫生安全更有保证。

HACCP Color Coding							
HACCP系列颜色分类说明	DAIRY 糕点及乳制品类	RAW MEAT 红肉类	SEAFOOD 海鲜类	COOKED FOOD 熟食类	VEGETABLE 蔬果类	POULTRY 家禽类	ALLERGEN SAFE 过敏原类

Sang Slicer Chinese Knife -No.1

桑刀(切+片), 一号

			
KB-1393-240-BK201-CP-CP	9.5"(240 x 100mm) Gauge (厚度): 2mm		24



Kau Kong Chinese Knife -No.1



九江刀(剃), 一号

			
KB-1383-190-BK201-CP-CP	7.5"(190 x 125mm) Gauge (厚度): 4mm		24

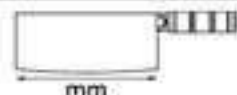

Slicer Chinese Knife -No.2

文刀(切+片), 二号

			
KB-1394-220-BK201-CP-CP	8.75"(220 x 115mm) Gauge (厚度): 2mm		24



Slicer & Chopper Chinese Knife -No.2

文武刀(切+片+轻剃), 二号

			
KB-1396-220-BK201-CP-CP	8.75"(220 x 115mm) Gauge (厚度): 3mm		24



Chopper Chinese Knife -No.2

武刀(切+剃), 二号

			
KB-1395-220-BK201-CP-CP	8.75"(220 x 115mm) Gauge (厚度): 6mm		24





Sang Slicer Chinese Knife
-No.2

桑刀(切+片), 二号

KB-1393-220-BK201-CP-CP	8.75"(220 x 95mm) Gauge(厚度): 2mm		24



Kau Kong Knife
-No.2

九江刀(剁), 二号

KB-1383-180-BK201-CP-CP	7"(180 x 115mm) Gauge(厚度): 4mm		24



Slicer Chinese Knife
-No.3

文刀(切+片), 三号

KB-1394-200-BK201-CP-CP	8"(200 x 85mm) Gauge(厚度): 2mm		24



Slicer & Chopper Chinese Knife
-No.3

文武刀(切+片+轻剁), 三号

KB-1396-200-BK201-CP-CP	8"(200 x 85mm) Gauge(厚度): 3mm		24



Chopper Chinese Knife
-No.3

武刀(切+剁), 三号

KB-1395-200-BK201-CP-CP	8"(200 x 85mm) Gauge(厚度): 4mm		24



Slicer Chinese Knife
-No.5

文刀(切+片), 五号

KB-1394-170-BK201-CP-CP	6.7"(170 x 80mm) Gauge(厚度): 2mm		24



Slicer & Chopper Chinese Knife
-No.5

文武刀(切+片+轻剁), 五号





KB-1396-170-BK201-CP-CP	6.7"(170 x 80mm) Gauge(厚度): 2.5mm		24

CHINESE KNIVES

厨王, 中厨系列

Chopper Chinese Knife -No.5

武刀(切+剁), 五号

			
KB-1395-170-BK201-CP-CP	6.7"(170 x 80mm) Gauge(厚度): 4mm		24



Utility, Chinese Knife





万用料理刀

			
KB-1384-180-BK201-CP-CP	7"(180 x 70mm) Gauge(厚度): 2mm		24



Slicer, Duck, Chinese Knife

片鸭刀





			
KB-1385-210-BK201-CP-CP	8.25"(210 x 51mm) Gauge(厚度): 2mm		24



Press Cleaver Chinese Knife

-No.3





拍皮刀(切面团), 三号

			
KB-1397-200-BK201-CP-CP	8"(200 x 85mm) Gauge(厚度): 2mm		24



Shanghai, Chinese Knife





上海式文刀(切+片)

			
KB-1386-220-BK201-CP-CP	8.75"(220 x 107mm) Gauge(厚度): 2mm		24



Shanghai, Chinese Knife

上海式文武刀(切+片+轻剁)

			
KB-1387-220-BK201-CP-CP	8.75"(220 x 107mm) Gauge(厚度): 3mm		24





Mincing Knife
-Single Blade

香草刀, 单刃

MK-S1-150-BK101-CP-CP		6"(150mm)	●	24
MK-S1-230-BK101-CP-CP		9"(230mm)	●	24

Mincing Knife
-Double Blade

香草刀, 双刃

MK-D1-150-BK101-CP-CP		6"(150mm)	●	24
MK-D1-230-BK101-CP-CP		9"(230mm)	●	24

Double Cheese Knife

双头芝士刀

KR-6463-250-BK301-CP-CP		10"(250mm)	●	24
KR-6463-300-BK301-CP-CP		12"(300mm)	●	24

Double Cheese Knife

双头芝士刀

KB-2263-360-BK101-CP-CP		14"(360mm)	●	24

Pizza Knife

披萨刀

KB-2261-410-BK101-CP-CP		16"(410mm)	●	24
KB-2261-460-BK101-CP-CP		18"(460mm)	●	24

Pizza Rocker Knife

双头披萨刀

KB-2262-510-BK101-CP-CP		20"(510mm)	●	24

Pizza Wheel

披萨刀

GS-30510-100-BK101-CP-CP		4"(100mm)	●●●●	48

Pizza Rocker
-S/S

披萨刀, 不锈钢

SS-62-350-CP-CP		14"(350mm)	S/S	50



DAMASCUS KNIVES

- Hand Crafted by Japanese CP-MAX 67 Layers Damascus Steel.
- Skillfully Honed 秀藏作® 22 degree cutting Edge, Laser Angle Tested, Enhanced Sharpness, Edge Holding & Ease of Re-Sharping.
- Ergonomic, Slip Resistant with D-Shaped, Ebony- Finished Carbon Fiber Handles. Seamless Design on Handle.
- Classic Wave and Mirror Design pattern are available for selection.

- 手工制作, 刀刃選用日本製67层 CP-MAX 大马士革钢材, 令刀锋更持久锋利, 坚韧耐用。
- 技术团队经长时间精心钻研, 寻求不同用途的刀, 对刀刃角度的要求, 在锋利及耐用两方面取得平衡, 形成秀藏作®独特的22角度刀刃加工技术, 配合以雷射角度测试仪来控制产品的质量, 保证刀具的刀刃锋利、持久耐用及锻修容易, 刀刃口不易崩缺或断裂。
- 秀藏作®以崭新的人体工学作为设计基本蓝本, 配合D型碳纤手柄, 握感平衡舒适, 稳固不滑, 长时间使用轻松自如。手柄不会脱落。产品设计不留缝隙驳口, 方便卫生。
- 经典波浪和镜面设计图案均可供选择!



Paring Knife

果皮刀, 日本大马士革

DM-5806-100	4"(100mm)	●	24



Steak Knife

牛扒刀, 日本大马士革

DM-5802-115	4.5"(115mm)	●	24

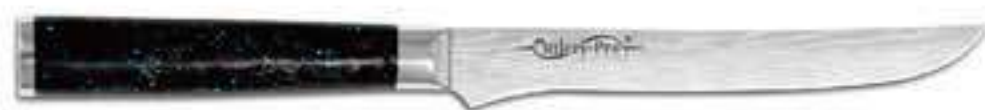

Boning Knife

-Straight & Narrow Blade

骨刀, 日本大马士革

DM-5808-150	6"(150mm)	●	24



Utility Knife

万用刀, 日本大马士革

DM-5805-150	6"(150mm)	●	24



Santoku Knife

三德刀, 日本大马士革

DM-5811-180	7"(180mm)	●	24



Slicer, Chinese

文刀, 日本大马士革

DM-5894-180	7"(180mm)	●	24



Cooks Knife

-Wide

厨刀, 宽, 日本大马士革

DM-5801-200W	8"(200mm)	●	24



Bread Knife

面包刀, 日本大马士革

DM-5855-230	9"(230mm)	●	24

DAMASCUS KNIVES

日本大马士革, 锤纹, 日厨系列

专业的产品给专业的您

- Hand Crafted by Japanese CP-MAX 67 Layers Damascus Steel.
- Skillfully Honed 秀藏作® 22 degree cutting Edge, Laser Angle Tested , Enhanced Sharpness, Edge Holding & Ease of Re-Sharpening.
- Ergonomic, Slip Resistant with D-Shaped, Ebony- Finished Carbon Fiber Handles. Seamless Design on Handle.
- Classic Wave and Mirror Design pattern are available for selection.
- 手工製作, 刀刃選用日本製67层 CP-MAX 大马士革钢材, 令刀锋更持久锋利, 坚韧耐用。
- 技术团队经长时间精心钻研, 寻求不同用途的刀, 对刀刃角度的要求, 在锋利及耐用两方面取得平衡, 形成 秀藏作® 独特的22角度刀刃加工技术, 配合以雷射角度测试仪来控制产品的质量, 保证刀具的刀刃锋利、持久耐用及锻修容易, 刀刃口不易崩缺或断裂。
- 秀藏作® 以崭新的人体工学作为设计基本蓝本, 配合D型碳纤手柄, 握感平衡舒适, 稳固不滑, 长时间使用轻松自如。手柄不会脱落。产品设计不留缝隙驳口, 方便卫生。
- 经典波浪和镜面设计图案均可供选择!



Paring Knife

果皮刀, 日本大马士革

DM-5906-100	4"(100mm)	●	24



Steak Knife

牛扒刀, 日本大马士革

DM-5902-115	4.5"(115mm)	●	24



Boning Knife

-Straight & Narrow Blade

骨刀, 日本大马士革

DM-5908-150	6"(150mm)	●	24



Utility Knife

万用刀, 日本大马士革

DM-5905-150	6"(150mm)	●	24



Santoku Knife

三德刀, 日本大马士革

DM-5921-180	7"(180mm)	●	24



Slicer, Chinese

文刀, 日本大马士革

DM-5994-180	7"(180mm)	●	24



Cooks Knife

-Wide

厨刀, 宽, 日本大马士革

DM-5901-200W	8"(200mm)	●	24



Bread Knife

面包刀, 日本大马士革

DM-5955-230	9"(230mm)	●	24



秀藏作[®]



Cutlery-Pro[®]
We are professional for
THE PROFESSIONAL

QINGSHANLI[®]

秀藏作[®]

• JAPANESE KNIVES •

JAPANESE KNIVES





专业的产品给专业的您

专业, 日厨系列

- Stamped From German Molybdenum Vanadium X50CrMoV15 Steel Alloy , Ice-Hardened available.
 - Skillfully Honed 秀藏作® cutting Edge, Laser Angle Tested , Enhanced Sharpness, Edge Holding & Ease of Re-Sharpening.
 - Ergonomic, Slip Resistant with German Beech wood. Seamless Design on Handle.
- 精选德国高级钼钒钢材X50CrMoV15精锻而成, 配以冰锻(Ice Hardened)技术处理, 令刀锋更持久锋利, 坚韧耐用。
 - 技术团队经长时间精心钻研, 寻求不同用途的刀, 对刀刃角度的要求, 在锋利及耐用两方面取得平衡, 形成秀藏作®独特的刀刃加工技术, 配合以雷射角度测试仪来控制产品的质量, 保证刀具的刀刃锋利、持久耐用及锻修容易, 刀刃口不易崩缺或断裂。
 - 秀藏作® 刀具以崭新的人体工学作为设计基本蓝本, 手柄的指撑设计, 配合德国榉木材料, 握感平衡舒适, 稳固不滑, 长时间使用轻松自如。手柄不会脱落。产品设计不留缝隙驳口, 方便卫生。





Santoku Knife

三德刀, 日式

			
JP-1111-165-CP-CP	6.5"(165mm)	●	24





Deba Knife

出刃

			
JP-1191-120-CP-CP	5"(120mm)	●	24
JP-1191-150-CP-CP	6"(150mm)	●	24





Deba Knife

出刃

			
JP-1191-165-CP-CP	6.5"(165mm)	●	24
JP-1191-180-CP-CP	7"(180mm)	●	24





Deba Knife

出刃

			
JP-1191-210-CP-CP	8.25"(210mm)	●	24
JP-1191-240-CP-CP	9.5"(240mm)	●	24





Nakiri Knife

菜切

			
JP-1133-165-CP-CP	6.5"(165mm)	●	24





Nakiri Knife

菜切

			
JP-1133-180-CP-CP	7"(180mm)	●	24
JP-1133-210-CP-CP	8.5"(210mm)	●	24





Sashimi Knife

柳刃

			
JP-1190-210-CP-CP	8"(210mm)	●	24





Sashimi Knife

菜切

			
JP-1190-240-CP-CP	10"(240mm)	●	24
JP-1190-270-CP-CP	10.5"(270mm)	●	24

Sashimi Knife

菜切

			
JP-1190-300-CP-CP	12"(300mm)	●	24
JP-1190-330-CP-CP	13"(330mm)	●	24
JP-1190-350-CP-CP	14"(350mm)	●	24



- Stamped From German Molybdenum Vanadium X50CrMoV15 Steel Alloy , Ice-Hardened available.
- Skillfully Honed 秀藏作® cutting Edge, Laser Angle Tested , Enhanced Sharpness, Edge Holding & Ease of Re-Sharping.
- Ergonomic, Slip Resistant with Derlin®, DuPONT® resin. Seamless Design on Handle.
- 精选德国高级钼钒钢材X50CrMoV15精锻而成, 配以冰锻 (Ice Hardened) 技术处理, 令刀锋更持久锋利, 坚韧耐用。
- 技术团队经长时间精心钻研, 寻求不同用途的刀, 对刀刃角度的要求, 在锋利及耐用两方面取得平衡, 形成 秀藏作® 独特的刀刃加工技术, 配合以雷射角度测试仪来控制产品的质量, 保证刀具的刀刃锋利、持久耐用及锻修容易, 刀刃口不易崩缺或断裂。
- 秀藏作® 刀具以崭新的人体工学作为设计基础蓝本, 手柄的指撑设计, 配合美国杜邦公司Delrin® 注塑材料, 握感平衡舒适, 稳固不滑, 长时间使用轻松自如。手柄不会脱落。
- 秀藏作® 刀具通过 NSF 美国国家卫生基金会 (National Sanitation Foundation) 认证; 配合 秀藏作® 专利的抗菌设计SteriShield®, 产品的卫生安全更有保证。产品设计不留缝隙驳口, 可放入洗碗碟机清洗, 方便卫生。



Cooks Knife
-Japanese

牛刀(分刀, 精锻)

FR-9686-150-BK301-CP-CP	6"(150mm)	●	24



Cooks Knife
-Japanese

牛刀(分刀, 精锻)

FR-9686-180-BK301-CP-CP	7"(180mm)	●	24
FR-9686-200-BK301-CP-CP	8"(200mm)	●	24



Cooks Knife
-Japanese

牛刀(分刀, 精锻)

FR-9686-240-BK301-CP-CP	9.5"(240mm)	●	24
FR-9686-265-BK301-CP-CP	10.5"(265mm)	●	24



Cooks Knife
-Japanese

牛刀(分刀, 精锻)

FR-9686-300-BK301-CP-CP	12"(300mm)	●	24



Cooks Knife
-Japanese

牛刀(分刀)

KR-6887-150-BK301-CP-CP	6"(150mm)	●	24



Cooks Knife
-Japanese

牛刀(分刀)

KR-6887-180-BK301-CP-CP	7"(180mm)	●	24
KR-6887-200-BK301-CP-CP	8"(200mm)	●	24



Cooks Knife
-Japanese

牛刀(分刀)

KR-6887-240-BK301-CP-CP	9.5"(240mm)	●	24
KR-6887-265-BK301-CP-CP	10.5"(265mm)	●	24



Cooks Knife
-Japanese

牛刀(分刀)



KR-6887-300-BK301-CP-CP	12"(300mm)	●	24



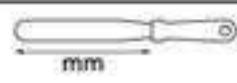

**CULINARY
INSTRUMENTS**

- Stamped From German Stainless Steel Alloy.
- Ergonomic, Slip Resistant with Polypropylene resin Seamless Design on Handle.
- Color Coding system available , Comply with HACCP regulation.
- NSF Certified  meet health and safety standards, Dishwasher Safe and SteriShield® Anti-Bacterial protection.
- 特选德国高级不锈钢钢材。
- 以崭新的人体力学作为设计基础蓝本, 手柄的指撑设计, 配合Polypropylene注塑材料, 握感平衡舒适, 稳固不滑, 长时间使用轻松自如。手柄不会脱落。
- 建立手柄颜色系统符合 HACCP 食品安全控制体系标准, 防止细菌交叉感染, 产品设计不留缝隙驳口, 可放入洗碗碟机清洗, 方便卫生。
-  刀具通过  美国国家卫生基金会 (National Sanitation Foundation) 认证; 配合  专利的抗菌设计SteriShield®, 产品的卫生安全更有保证。



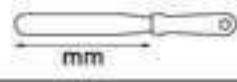

Spreader -Plain				刮, 平口
		mm		
GS-30509-85P-WH101-CP-CP	3.25"(85mm)	☾		48



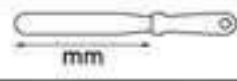

Spreader -Serrated				刮, 齿
		mm		
GS-30509-85S-WH101-CP-CP	3.25"(85mm)	☾		48



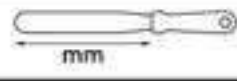

Turner				西铲
		mm		
GS-30502-80-WH101-CP-CP	3"(80mm)	☾		48



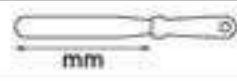

Pie Server				饼铲
		mm		
GS-30501-55-WH101-CP-CP	2.25x4"(55mm)	☾		48



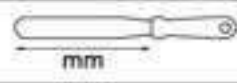

Pie Server				饼铲
		mm		
GS-30501-130-WH101-CP-CP	5"(130mm)	☾		48



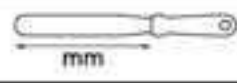

Pie Server				饼铲
		mm		
GS-30502-65-WH101-CP-CP	2.5x4"(65mm)	☾		48



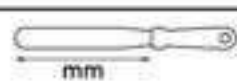

Turner				西铲
		mm		
GS-30502-13/5-WH101-CP-CP	2x5"(130 mm)	☾		48



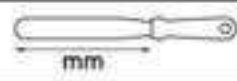

Turner -Perforated				西铲, 有孔
		mm		
GS-30502-13/5H-WH101-CP-CP	2x5"(130 mm)	☾		48



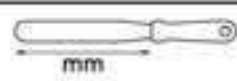

Turner				西铲
		mm		
GS-30502-11/9-WH101-CP-CP	4.5x3.5"(115 mm)	☾		48



Turner -Perforated				西铲, 有孔
		mm		
GS-30502-11/9H-WH101-CP-CP	4.5x3.5"(115 mm)	☾		48

Pie Server

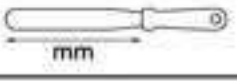

饼铲

			
GS-30501-140-WH101-CP-CP	5.5x3"(140mm)	☾	48



Turner

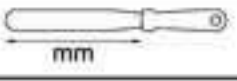

西铲

			
GS-30502-110-WH101-CP-CP	4.5x3.125"(110mm)	☾	48



Turner

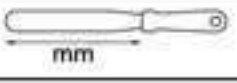

西铲

			
GS-30502-115-WH101-CP-CP	4.5x3"(115mm)	☾	48



Turner

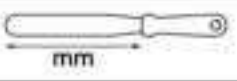

西铲

			
GS-30502-130-WH101-CP-CP	5x4"(130mm)	☾	48



Turner

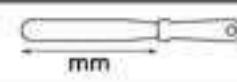

西铲

			
GS-30502-15/13-WH101-CP-CP	6x5"(150mm)	☾	48



Turner

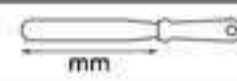

西铲

			
GS-30502-150-WH101-CP-CP	6x3"(150mm)	☾	48



Turner
-Wide

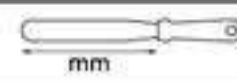

西铲, 宽

			
GS-30502-150W-WH101-CP-CP	6x4"(150mm)	☾	48



Turner

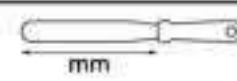

西铲

			
GS-30502-200-WH101-CP-CP	8x3"(200mm)	☾	48



Turner
-Perforated

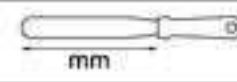



西铲, 有孔

			
GS-30502-200H-WH101-CP-CP	8x3"(200mm)	☾	48



Turner
-Wide



西铲, 宽

			
GS-30502-200W-WH101-CP-CP	8x4"(200mm)	☾	48

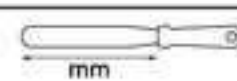

Turner
-Wide

西铲, 宽

			
GS-30502-250W-WH101-CP-CP	10x4"(250mm)	☾	48



CULINARY INSTRUMENTS

西铲烘焙系列



Dough Cutter

切丝刮

GS-30504-150-WH101-CP-CP	6"(150mm)	☐	48



Scraper

万用刮

GS-30514-115-WH101-CP-CP	4.5"(115mm)	☐	48



Fish Spatula

鱼刮

GS-30512-180-WH101-CP-CP	7"(180mm)	☐	48



Carrot Knife
-Serrated

萝卜刀, 齿

GS-30506-170S-WH101-CP-CP	6.5" (170mm)	☐	48



Carving Fork
-Curved

叉, 弯

GS-30544-200C-WH101-CP-CP	8"(200mm)	☐	48



Carving Fork

叉

GS-30544-180-WH101-CP-CP	7"(180mm)	☐	48



Turner
-Pancake

西铲, 蛋糕

GS-30502-16/19-WH101-CP-CP	6.5x7.5"(170x190mm)	☐	24





Turner, Cake
-Round Head

西铲, 蛋糕, 圆头

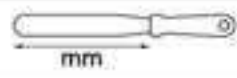

GS-30502-250R-WH101-CP-CP	10"(250mm)	☐	12
GS-30502-300R-WH101-CP-CP	12"(300mm)	☐	12

Spatula 蛋糕刮

			
GS-30508-80-WH101-CP-CP	3"(80mm)	☾	48



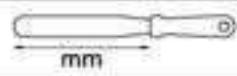

Spatula 蛋糕刮

			
GS-30508-110-WH101-CP-CP	4.25"(110mm)	☾	48



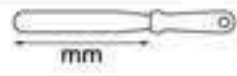

Spatula 蛋糕刮

			
GS-30508-150-WH101-CP-CP	6"(150mm)	☾	48
GS-30508-200-WH101-CP-CP	8"(200mm)	☾	48



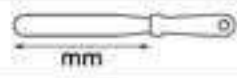

Spatula 蛋糕刮

			
GS-30508-250-WH101-CP-CP	10"(250mm)	☾	48



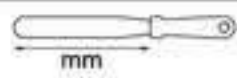

Spatula 蛋糕刮

			
GS-30508-300-WH101-CP-CP	12"(300mm)	☾	48



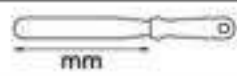

Spatula 蛋糕刮

			
GS-30508-350-WH101-CP-CP	14"(350mm)	☾	48



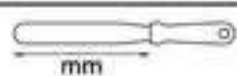

Spatula -Serrated 蛋糕刮, 齿

			
GS-30508-350S-WH101-CP-CP	14"(350mm)	☾	48



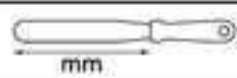



Spatula -Offset 蛋糕刮, 曲

			
GS-30508-80FS-WH101-CP-CP	3"(80mm)	☾	48





Spatula -Offset 蛋糕刮, 曲

			
GS-30508-110FS-WH101-CP-CP	4.25"(110mm)	☾	48



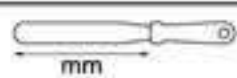

Spatula -Offset 蛋糕刮, 曲

			
GS-30508-150FS-WH101-CP-CP	6"(150mm)	☾	48
GS-30508-200FS-WH101-CP-CP	8"(200mm)	☾	48



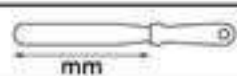

Spatula -Offset 蛋糕刮, 曲

			
GS-30508-250FS-WH101-CP-CP	10"(250mm)	☾	48



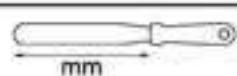

Spatula -Offset 蛋糕刮, 曲

			
GS-30508-300FS-WH101-CP-CP	12"(300mm)	☾	48

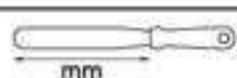

Spatula -Offset 蛋糕刮, 曲

			
GS-30508-350FS-WH101-CP-CP	14"(350mm)	☾	48





Spatula

蛋糕刮

GS-80208-80-CP-CP	3"(80mm)		48



Spatula

蛋糕刮

GS-80208-110-CP-CP	4.25"(110mm)		48



Spatula

蛋糕刮

GS-80208-150-CP-CP	6"(150mm)		48



Spatula

蛋糕刮

GS-80208-200-CP-CP	8"(200mm)		48
GS-80208-250-CP-CP	10"(250mm)		48



Spatula

蛋糕刮

GS-80208-300-CP-CP	12"(300mm)		48



Spatula

蛋糕刮

GS-80208-350-CP-CP	14"(350mm)		48



Spatula

-Offset

蛋糕刮, 曲

GS-80208-80FS-CP-CP	3"(80mm)		48



Spatula

-Offset

蛋糕刮, 曲

GS-80208-110FS-CP-CP	4.25"(110mm)		48



Spatula

-Offset

蛋糕刮, 曲

GS-80208-150FS-CP-CP	6"(150mm)		48



Spatula

-Offset

蛋糕刮, 曲

GS-80208-200FS-CP-CP	8"(200mm)		48
GS-80208-250FS-CP-CP	10"(250mm)		48



Spatula

-Offset

蛋糕刮, 曲

GS-80208-300FS-CP-CP	12"(300mm)		48



Spatula

-Offset

蛋糕刮, 曲

GS-80208-350FS-CP-CP	14"(350mm)		48

Swivel Peeler

-PP



PEEL-PP-55S-OR103-CP-CP

PEEL-PP-55S-BL101-CP-CP

PEEL-PP-55S-GR101-CP-CP

PEEL-PP-55S-RD101-CP-CP

PEEL-PP-55S-YL104-CP-CP

- Stamped From German Stainless Steel Alloy.
- Ergonomic, Slip Resistant & Seamless Design on Handle.
- Seamless, Completely Hygenic Handle Construction.
- 特选德国高级不锈钢钢材。
- 刀具以崭新的人体力学作为设计基础蓝本, 手柄握感平衡舒适, 稳固不滑, 长时间使用轻松自如。手柄不会脱落。
- 产品的卫生安全更有保证。产品设计不留缝隙驳口, 可放入洗碗碟机清洗, 方便卫生。



Melon Baller

西瓜匙, 单头

	mm		
GS-10942-10-BK101-CP-CP	Φ10mm	●	96
GS-10942-15-BK101-CP-CP	Φ15mm	●	96
GS-10942-22-BK101-CP-CP	Φ22mm	●	96
GS-10942-25-BK101-CP-CP	Φ25mm	●	96
GS-10942-30-BK101-CP-CP	Φ30mm	●	96



Melon Baller -Oval

椭圆匙, 单头

	mm		
GS-10942-26VL-BK101-CP-CP	N/A	●	96



Melon Baller -Scalloped

花形匙, 单头

	mm		
GS-10942-30S-BK101-CP-CP	N/A	●	96



Melon Baller -Heart Shape

心形匙, 单头

	mm		
GS-10942-27HS-BK101-CP-CP	N/A	●	96



Tomato Shark

番茄匙, 单头

	mm		
GS-10936-22-BK101-CP-CP	Φ22mm	●	96



Lemon Zester -Combination Zester

柠檬刀, 有孔

	mm		
GS-10927-CZ-BK101-CP-CP	N/A	●	96



Lemon Zester

柠檬刀, 无孔

	mm		
GS-10927-ZS-BK101-CP-CP	N/A	●	96



Channel Knife

坑纹刀

	mm		
GS-10928-BK101-CP-CP	N/A	●	96



Channel Knife -Left Hand

坑纹刀, 左手

	mm		
GS-10928-LH-BK101-CP-CP	N/A	●	96



Channel Knife -Right Hand

坑纹刀, 右手

	mm		
GS-10928-RH-BK101-CP-CP	N/A	●	96

Citrus Peeler 橙皮刀

GS-10943-BK101-CP-CP	N/A	●	96



Vegetable Peeler 蔬菜刨

GS-10926-65SOP-BK101-CP-CP	65mm	●	96
GS-10926-80SOP-BK101-CP-CP	80mm	●	96



Melon Baller 西瓜匙, 双头

GS-10832-22/25-BK201-CP-CP	Φ22/25mm	●	96
GS-10832-22/30-BK201-CP-CP	Φ22/30mm	●	96



Melon Baller -Serrated/ Tomato Shark 西瓜匙, 双头, 齿/番茄匙

GS-10832-30S/36-22-BK201-CP-CP	Φ30/22mm	●	96



Melon Baller -Oval/Scalloped 花匙, 双头

GS-10832-26VL/30S-BK201-CP-CP	N/A	●	96



Double Lemon Zester & Channel Knife 两用匙, 双头

GS-10827/28-ZS-BK201-CP-CP	Φ22/25mm	●	96



Corer, Apple 苹果刀

GS-10923-75-BK101-CP-CP	75mm	●	96
GS-10923-100-BK101-CP-CP	100mm	●	96



Corer -Heart Shape 苹果刀, 心形

GS-10923-SHS-BK101-CP-CP	W=20mm	●	96
GS-10923-BHS-BK101-CP-CP	W=28mm	●	96



Butter Curler -Serrated 牛油弯刀, 齿

GS-10929S-BK101-CP-CP	N/A	●	96



Butter Curler -Plain 牛油弯刀, 平口

GS-10929P-BK101-CP-CP	N/A	●	96



Zucchini Corer 胡瓜刀

GS-10941-110-BK101-CP-CP	110mm	●	96



Zucchini Corer -V Shape 胡瓜刀, V形刀

GS-10941-110V-BK101-CP-CP	110mm	●	96





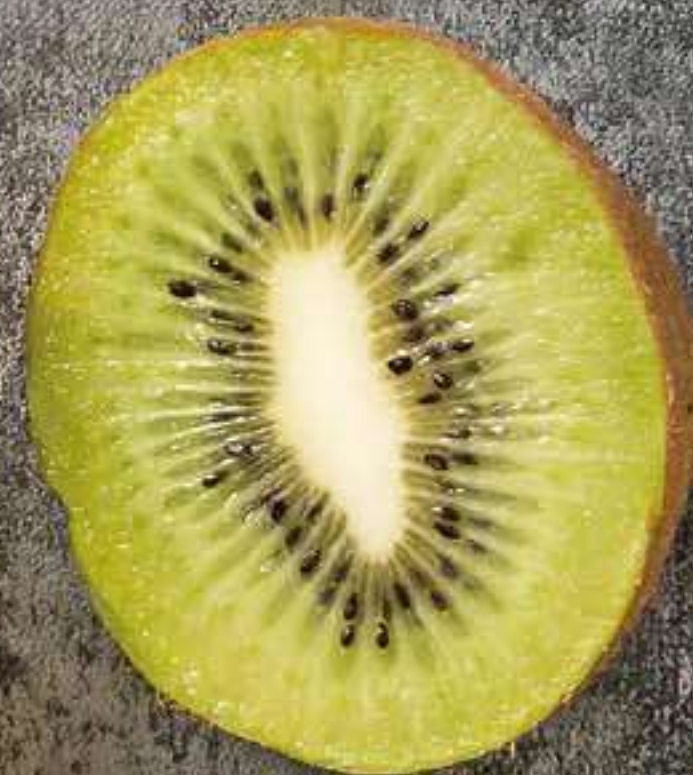

Y-Peeler



雕饰系列





Swivel Peeler
-PP

			
PEEL-PP-55S-OR103-CP-CP	55mm		96

C形刨







Y-Peeler

			
Y-PEEL-PP-55P-OR103-CP-CP	55mm		96

Y形刨

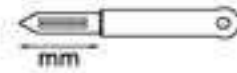





Grapefruit Peeler

			
GS-10939-110-BK101-CP-CP	110mm		96

西柚刀







Decorating Knife

			
GS-10951-90-BK101-CP-CP	90mm		96

装饰刀







Tomato Knife

			
GS-10917-110-BK101-CP-CP	110mm		96

番茄刀

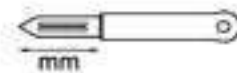





Cheese Knife

			
GS-10931-160-BK101-CP-CP	160mm		96

芝士刀

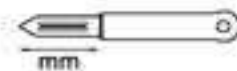





Cheese Knife
-Hard

			
GS-10964-130-BK101-CP-CP	130mm		96

芝士刀, 硬切







Cheese Knife
-Semi-Soft

			
GS-10963-130-BK101-CP-CP	130mm		96

芝士刀, 软切

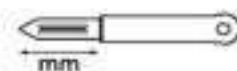



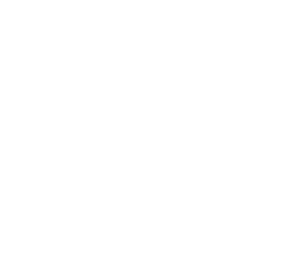

V Shape Decor Knife

			
GS-10952-85V-BK101-CP-CP	85mm		96
GS-10952-110V-BK101-CP-CP	110mm		96

V形装饰刀







V Shape Decor Knife
-Curved

			
GS-10952-100C-BK101-CP-CP	100mm		96

V形装饰刀, 弯

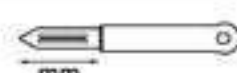

Triangle Curved Knife

			
GS-10946-BK101-CP-CP	N/A		96

三角形雕刻刀





Plain
平口



Serrated
齿



Julienne
分条



Swivel Peeler
-ABS

C形刨, ABS

GS-10824-SPJ-BK201-CP-CP		N/A	●	96
GS-10824-SPS-BK201-CP-CP		N/A	●	96
GS-10824-SPP-BK201-CP-CP		N/A	●	96

Swivel Peeler
-S/S

C形刨, 不锈钢

GS-10924-SPJ-BK101-CP-CP		N/A	●	96
GS-10924-SPS-BK101-CP-CP		N/A	●	96
GS-10924-SPP-BK101-CP-CP		N/A	●	96

Y- Peeler
-Serrated

Y形刨, 齿

GS-10825-55-SPP-BK101-CP-CP		55mm	●	96
GS-10825-55-SPS-BK101-CP-CP		55mm	●	96
GS-10825-55-SPJ-BK101-CP-CP		55mm	●	96
GS-10825-75-SPS-BK201-CP-CP		75mm	●	96

Y- Peeler
-S/S

Y形刨, 不锈钢

PEEL-SS-55P-CP-CP		55mm	●	96
PEEL-SS-55S-CP-CP		55mm	●	96
PEEL-SS-55J-CP-CP		55mm	●	96

Y- Peeler
-S/S,Serrated

Y形刨, 不锈钢, 齿

GS-10925-SS-BK101-CP-CP		N/A	●	96

Pastry Wheel
-Single,Plain

意粉刀, 单头, 平口

GS-10920-40P-BK101-CP-CP		Φ40mm	●	96
GS-10920-60P-BK101-CP-CP		Φ60mm	●	96

Pastry Wheel
-Single,Serrated

意粉刀, 单头, 齿

GS-10920-40S-BK101-CP-CP		Φ40mm	●	96
GS-10920-60S-BK101-CP-CP		Φ60mm	●	96

Pastry Wheel
-Double

意粉刀, 双头

GS-10922-40-BK101-CP-CP		Φ40mm	●	96
GS-10922-60-BK101-CP-CP		Φ60mm	●	96

Pastry Crimper

卷边器

GS-10945-BK101-CP-CP		N/A	●	96

Pastry Cutter

披萨刀

GS-10921-70-BK101-CP-CP		Φ70mm	●	96
GS-10921-100-BK101-CP-CP		Φ100mm	●	96

Ice-Cream Spoon 雪糕勺

GS-10833-BK101-CP-CP	N/A	●	96



Meat Tenderizers 肉锤

GS-10937-42-BK101-CP-CP	42mm	●	48
GS-10937-54-BK101-CP-CP	54mm	●	48



Cheese Plane -Soft 芝士刨, 软切

GS-10930-SO-BK101-CP-CP	N/A	●	96



Cheese Plane -Hard 芝士刨, 硬切

GS-10930-HD-BK101-CP-CP	N/A	●	96



Cheese Plane -Grater 芝士刨, 有孔

GS-10930-GE-BK101-CP-CP	N/A	●	96



Barrel-Shaped Whips 打蛋器, 不锈钢, 球形

GS-10958-BK101-CP-CP	N/A	●	96



Spiral Whips -100mm 打蛋器, 不锈钢, 螺旋形

GS-10948-100-BK101-CP-CP	100mm	●	96



Spiral Whips -165mm 打蛋器, 不锈钢, 螺旋形

GS-10948-165-BK101-CP-CP	165mm	●	96



Whips -S/S 打蛋器, 不锈钢

GS-10938-110-BK101-CP-CP	110mm	●	48
GS-10938-170-BK101-CP-CP	170mm	●	48



Potato Masher 压薯器

GS-10915-120-BK101-CP-CP	165mm	●	48



Can Opener 开罐器

GS-10940-01-BK101-CP-CP	N/A	●	48



Garlic Press 压蒜器, 带篮子

GS-10934-BK101-CP-CP	N/A	●	48





Graters Etching
-Coarse Edge

大孔电蚀刨

GS-10935-CE-BK101-CP-CP	N/A	●	48



Graters Etching
-Coarse Edge,Narrow

大孔电蚀刨,窄

GS-10935-CEN-BK101-CP-CP	N/A	●	48



Graters Etching
-Medium Edge

中孔电蚀刨

GS-10935-ME-BK101-CP-CP	N/A	●	48



Graters Etching
-Medium Edge,Narrow

中孔电蚀刨,窄

GS-10935-MEN-BK101-CP-CP	N/A	●	48



Graters Etching
-Fine Edge

细孔电蚀刨

GS-10935-FE-BK101-CP-CP	N/A	●	48



Graters Etching
-Fine Edge,Narrow

细孔电蚀刨,窄

GS-10935-FEN-BK101-CP-CP	N/A	●	48



Graters Etching
-Onion Edge

洋葱电蚀刨

GS-10935-ON-BK101-CP-CP	N/A	●	48



Graters Etching
-Onion Edge,Narrow

洋葱电蚀刨,窄

GS-10935-ONN-BK101-CP-CP	N/A	●	48



Graters Etching
-Potato Edge

薯仔电蚀刨

GS-10935-PO-BK101-CP-CP	N/A	●	48



Graters Etching
-Potato Edge,Narrow

薯仔电蚀刨,窄

GS-10935-PON-BK101-CP-CP	N/A	●	48





SHEARS

专业的产品给专业的您

厨房剪刀

Kitchen Shear





厨房剪刀, 单色

			
PS-2202-195T-BK-CP-CP	7.75"(195mm)	●	48



Kitchen Shear

厨房剪刀, 单色





			
PS-2202-215T-BK-CP-CP	8.5"(215mm)	●	48



Kitchen Shear

-Softgrip & Detachable

厨房剪刀, 双色, 可分离, PP, 橡胶





			
PS-2202-195TD-BK/DGY-CP-CP	7.75"(195mm)	●	48



Kitchen Shear

-Softgrip & Detachable

厨房剪刀, 双色, 可分离, PP, 橡胶





			
PS-2202-215TD-BK/DGY-CP-CP	8.5"(215mm)	●	48



Kitchen Shear

-Softgrip & Detachable

厨房剪刀, 双色, 可分离, PP, 橡胶





			
PS-2209-220TD-BK/DGY-CP-CP	8.75"(220mm)	●	48



Poultry Shear

-Softgrip





厨房鸡剪, 双色, PP, 橡胶

			
PS-2205-240-BK/DGY-CP-CP	9.5"(240mm)	●	48



Hak Japanese Scissors

家用剪刀, 单色, PVC, RD





			
PS-2501-165-RD-CP-CP	6.5"(165mm)	●	48



Herbs Shear

-Softgrip

香草剪, 双色, PP, 橡胶

			
PS-2213-200-GR/GR-CP-CP	8"(200mm)	●	48



Mini Food Tongs

Silicone Head, S/S, 45 Pcs set



SS-FTS-180-YL804-CP-CP
7" Mini Food Tongs, Silicone Head, S/S

SS-FTS-180-GR805-CP-CP
7" Mini Food Tongs, Silicone Head, S/S

SS-FTS-180-RD805-CP-CP
7" Mini Food Tongs, Silicone Head, S/S

SS-FTS-180-OR803-CP-CP
7" Mini Food Tongs, Silicone Head, S/S



SS-FTS-180-BL801-CP-CP
7" Mini Food Tongs, Silicone Head, S/S



Food Tongs

-S/S,Thick Gauge

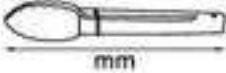
食物夹, 不锈钢, 加厚





				
SS-FT-180TG-CP-CP		7" (180mm)	S/S	48
SS-FT-230TG-CP-CP		9" (230mm)	S/S	48
SS-FT-300TG-CP-CP		12" (300mm)	S/S	48
SS-FT-350TG-CP-CP		14" (350mm)	S/S	48
SS-FT-400TG-CP-CP		16" (400mm)	S/S	48



Food Tongs

-S/S,AU

食物夹, 澳式, 不锈钢



				
SS-FT-180AU-CP-CP		7" (180mm)	S/S	48
SS-FT-240AU-CP-CP		9" (230mm)	S/S	48



Food Tongs

-S/S,European

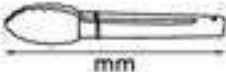
食物夹, 欧式, 不锈钢



				
SS-FT-230EU-CP-CP		9" (230mm)	S/S	48
SS-FT-300EU-CP-CP		12" (300mm)	S/S	48
SS-FT-350EU-CP-CP		14" (350mm)	S/S	48
SS-FT-400EU-CP-CP		16" (400mm)	S/S	48



Food Tongs

-Stainless Head,S/S,
With Silicone Handle,Silicone Lock

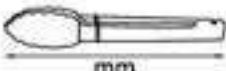
食物夹, 不锈钢头,
不锈钢加硅胶柄, 硅胶钩



				
SGS-FT-230-CP-CP		9" (230mm)	S/S	48
SGS-FT-300-CP-CP		12" (300mm)	S/S	48
SGS-FT-350-CP-CP		14" (350mm)	S/S	48
SGS-FT-400-CP-CP		16" (400mm)	S/S	48



Food Tongs

-Color Code,S/S

食物夹, 不锈钢头, 颜色柄



				
SG-FTC-230-BK-CP-CP		9" (230mm)		48
SG-FTC-300-BK-CP-CP		12" (300mm)		48



Food Tweezer

-Pointed,Tip,S/S

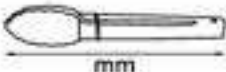
食物夹, 尖头, 不锈钢



				
SS-FC71-160PT-CP-CP		6.25" (160mm)	S/S	100
SS-FC71-210PT-CP-CP		8.25" (210mm)	S/S	100



Food Tweezer

-S/S

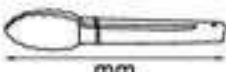
食物夹, 不锈钢





				
SS-FC72-210-CP-CP		8.25" (210mm)	S/S	100
SS-FC72-240-CP-CP		9.5" (240mm)	S/S	100
SS-FC72-300-CP-CP		12" (300mm)	S/S	100
SS-FC72-350-CP-CP		14" (350mm)	S/S	100
SS-FC72-400-CP-CP		16" (400mm)	S/S	100



Food Tweezer

-Offset,S/S

食物夹, 曲, 不锈钢

				
SS-FC72-210FS-CP-CP		8.25" (210mm)	S/S	100
SS-FC72-240FS-CP-CP		9.5" (240mm)	S/S	100
SS-FC72-300FS-CP-CP		12" (300mm)	S/S	100
SS-FC72-350FS-CP-CP		14" (350mm)	S/S	100
SS-FC72-400FS-CP-CP		16" (400mm)	S/S	100





Food Tongs

-Silicone Head, S/S,
With Silicone Handle, Silicone Lock



SG-FT-300-YL804-CP-CP
12" Food Tongs, Silicone Head, S/S With Silicone Handle, Silicone Lock

SG-FT-300-GR805-CP-CP
12" Food Tongs, Silicone Head, S/S With Silicone Handle, Silicone Lock

SG-FT-300-OR803-CP-CP
12" Food Tongs, Silicone Head, S/S With Silicone Handle, Silicone Lock

SG-FT-300-BK-CP-CP
12" Food Tongs, Silicone Head, S/S With Silicone Handle, Silicone Lock

SG-FT-300-BL-CP-CP
12" Food Tongs, Silicone Head, S/S With Silicone Handle, Silicone Lock

SG-FT-300-RD805-CP-CP
12" Food Tongs, Silicone Head, S/S With Silicone Handle, Silicone Lock



Scallop Knife

-S/S





扇贝刀, 不锈钢

			
SS-SK19-210-CP-CP	8.25"(210mm)	S/S	96

Abalone Knife

-S/S





鲍鱼刀, 不锈钢

			
SS-AK05-250-CP-CP	10"(250mm)	S/S	96

Serving Tong



-S/S

服务夹, 不锈钢

			
SS-SEV-200-CP-CP	8"(200mm)	S/S	48
SS-SEV-250-CP-CP	10"(250mm)	S/S	48

Fish Bone Tweezer

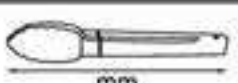

鱼骨夹

			
GS-10313-110-CP-CP	4.25"(110mm)	S/S	96

Tong Spaghetti

-S/S

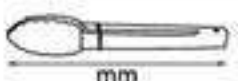

沙拉夹, 不锈钢

			
SS-SPT-200-CP-CP	8" (200mm)	S/S	96

Pastry Tongs

-Oval,S/S

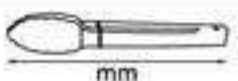
意粉夹, 椭圆形, 不锈钢

			
SS-PAS-240VL-CP-CP	9.5" (240mm)	S/S	96

Pastry Tongs

-Round,S/S



意粉夹, 圆形, 不锈钢

			
SS-PAS-240RD-CP-CP	9.5" (240mm)	S/S	96

Utility Tongs

-S/S

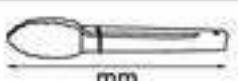

万能夹, 不锈钢

			
SS-UTL-220-CP-CP	8.75" (220mm)	S/S	96

Utility Tongs

-Perforated,S/S

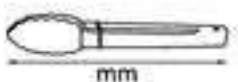

万能夹, 有孔, 不锈钢

			
SS-UTL-200H-CP-CP	8" (200mm)	S/S	96

Measuring Spoon

-S/S

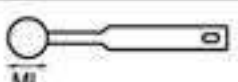



量匙, 不锈钢

			
SS-MS-01-CP-CP	1.25,2.5,5,15	S/S	96

Measuring Cup

-S/S

量杯, 不锈钢

			
SS-MC-01-CP-CP	60,80,125,250	S/S	48

Apple Slicer

苹果切片器

			
SLIC-APPL-01-CP-CP	N/A	S/S	96



Cutlery-Pro®
We are professional for
THE PROFESSIONAL



Whetstone, Sharpener

磨刀石

Product Code	Grain	Material	Quantity
WS-24/80-CP-CP	240/800Grit/目	S/S	20
WS-60/100-CP-CP	600/1000Grit/目	S/S	20
WS-200/500-CP-CP	2000/5000Grit/目	S/S	20



Dual Action Sharpener

-Carbide & Ceramic

磨刀座, 陶瓷金刚石

Product Code	Material	Quantity
CP-SHAP-01-CP-CP	N/A	48



Sharpening Steel

磨刀棒

Product Code	Length	Color	Quantity
KB-7577-230-BK101-CP-CP	9" (230mm)	Red, Green, Blue, Yellow	24
KB-7577-300-BK101-CP-CP	12" (300mm)	Red, Green, Blue, Yellow	24
KB-7577-350-BK101-CP-CP	14" (350mm)	Red, Green, Blue, Yellow	24



Sharpening Steel

-Diamond

磨刀棒, 钻石

Product Code	Length	Color	Quantity
KB-7477-300DM-BK101-CP-CP	12" (300mm)	Red, Green, Blue, Yellow	24



New! Professional For Butcher Sharpening-German Molybdenum Vanadium Steel

Sharpening Steel

磨刀棒

Product Code	Length	Color	Quantity
KB-1877-300-BK101-CP-CP	12" (300mm)	Red, Green, Blue, Yellow	24



Sharpening Steel

-Fine Cut

磨刀棒, 幼齿

Product Code	Length	Color	Quantity
KB-1877-300FT-BK101-CP-CP	12" (300mm)	Red, Green, Blue, Yellow	24



Magnetic Rack

磁力架

Product Code	Length	Color	Quantity
BT-TM06-300-CP-CP	12" (300mm)	Black	24
BT-TM06-450-CP-CP	18" (450mm)	Black	12
BT-TM06-600-CP-CP	24" (600mm)	Black	12



Knife Guard

-Wide

刀套, 宽

Product Code	Length	Color	Quantity
ES-309-CP-CP	6" (165x41mm)	Black	144
ES-304-CP-CP	6" (165x50mm)	Black	144
ES-305-CP-CP	8" (212x50mm)	Black	144
ES-308-CP-CP	10" (264x53mm)	Black	144
ES-314-CP-CP	12" (315x53mm)	Black	144



Knife Guard

-Narrow

刀套, 窄

Product Code	Length	Color	Quantity
ES-301-CP-CP	4" (103x28mm)	Black	144
ES-302-CP-CP	5" (132x28mm)	Black	144
ES-303-CP-CP	6" (158x28mm)	Black	144
ES-306-CP-CP	8" (222x32mm)	Black	144
ES-313-CP-CP	9" (242x35mm)	Black	144
ES-307-CP-CP	10" (264x35mm)	Black	144
ES-310-CP-CP	12" (315x38mm)	Black	144



Knife Guard

刀套

Product Code	Length	Color	Quantity
ES-311-CP-CP	16" (417x57mm)	Black	144
ES-312-CP-CP	17" (432x57mm)	Black	144



*BAGS ONLY

7 Piece Garnishing W/Pouch Set		雕饰袋, 7件装	
			
RO-005-CP-CP	7 pockets	●	48



6 Pocket Knife Case Set		刀袋, 6件装	
			
RO-004-CP-CP	6 pockets	●	10



16 Pocket Knife Case Set		刀袋, 16件装	
			
RO-006-CP-CP	16 pockets	●	10



11 Pocket Knife Case Set		刀袋, 11件装	
			
RO-001-CP-CP	11 pockets	●	10



Double -Zip 17 Pocket Knife Case Set		刀袋, 2层, 17件装	
			
RO-008-CP-CP	17 pockets	●	10



Triple -Zip 26 Pocket Knife Case Set		刀袋, 3层, 26件装	
			
RO-007-CP-CP	26 pockets	●	10



ALUMINIUM BRIEF CASE

KNIVES ACCESSORIES



KFE-AT-43/001-CP-CP
Aluminium Brief Case Chefs Set
-43 Pcs Set (铝箱刀套装, 43件装)

GAD-AT-62/001-CP-CP
Aluminium Brief Case Bakery Set
-62 Pcs Set (铝箱刀套装, 62件装)







Decoration

Tubes-Plain 平口花嘴

PNS-1.0—PNS-9.0	S: Φ 18mm	S/S	1000
PNM-2.0—PNM-13	M: Φ 24mm	S/S	1000
PNL-10—PNL-16	L: Φ 30mm	S/S	1000

Tubes-Curved Closed Star 歪齿花嘴

CCS-1.0	S: Φ 18mm	S/S	1000
CCM-8.0	M: Φ 24mm	S/S	1000
CCL-6.0、CCL-8.0、CCL-9.0	L: Φ 30mm	S/S	1000

Tubes-Closed Star 弯齿花嘴

CSS-1.0—CSS-4.0	S: Φ 18mm	S/S	1000
CSM-6.0、CSM-8.0	M: Φ 24mm	S/S	1000
CSL-6.0—CSL-10	L: Φ 30mm	S/S	1000

Tubes-Open Star 直齿花嘴

OSS-1.5—OSS-7.0	S: Φ 18mm	S/S	1000
OSM-2.0—OSM-10	M: Φ 24mm	S/S	1000
OSL-9.0—OSL-15	L: Φ 30mm	S/S	1000

Tubes-French Star 多齿花嘴

FHS-6.0—FHS-8.0	S: Φ 18mm	S/S	1000
FHM-5.0—FHM-12	M: Φ 24mm	S/S	1000
FHL-9.0—FHL-18	L: Φ 30mm	S/S	1000

Tubes-Multi Open 多孔花嘴

MOS-233	S: Φ 18mm M: Φ 24mm	S/S	1000

Tubes-Fritter 泡芙嘴

TB-90	S: Φ 18mm	S/S	1000
TB-78	M: Φ 18mm	S/S	1000
TB-69	L: Φ 25mm	S/S	1000

Tubes-Petal 花形花嘴

PLS-062、PLS-059、PLS-061	S: Φ 18mm	S/S	1000
PLS-097、PLS-101、PLS-102	S: Φ 18mm	S/S	1000
PLS-103、PLS-104、PLS-158	S: Φ 18mm	S/S	1000
PLM-123—PLM-127	M: Φ 24mm	S/S	1000
PLM-402、PLM-1765	M: Φ 24mm	S/S	1000



Tubes-Petal 花形花嘴

PLX-6182、PLX-6183	XL: Φ 36mm	S/S	1000

Tubes-Special 特别齿花嘴

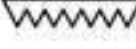

SPX-6181	XL: Φ 36mm	S/S	1000

Tubes-Blasket Wave		网纹花嘴		
BWS-045—BWS-048	S: Φ 18mm	S/S	1000	
BWS-481、BWS-7051、BWS-7052	S: Φ 18mm	S/S	1000	
BWM-02B、BWM-895、BWM-368	M: Φ 24mm	S/S	1000	









Tubes-Leaf		叶形花嘴		
LFS-067—LFS-071	S: Φ 18mm	S/S	1000	
LFS-074、LFS-352、LFS-353	S: Φ 18mm	S/S	1000	
LFM-112、LFM-115、LFM-366	M: Φ 24mm	S/S	1000	









Tubes-Drop Flower		螺旋形花嘴		
DFS-029、DFS-054、DFS-129P	S: Φ 18mm	S/S	1000	
DFS-131P、DFS-225、DFS-106、DFS-7086	S: Φ 18mm	S/S	1000	
DFM-6B、DFM-02C、DFM-02D	M: Φ 24mm	S/S	1000	
DFM-2F、DFM-109、DFM-195、DFM-7174	M: Φ 24mm	S/S	1000	
DFL-1767、DFL-01E、DFL-01F	L: Φ 30mm	S/S	1000	



Tubes-Ruffle		波纹形花嘴		
RUS-062、RUS-086、RUS-098、RUS-154	S: Φ 18mm	S/S	1000	
RUM-134、RUM-158	M: Φ 24mm	S/S	1000	

Tubes-V-cut		V形花嘴		
VCM-580、VCM-580S	M: Φ 24mm	S/S	1000	

Tubes-Special		特别齿花嘴		
SPS-028、SPS-078、SPS-081	S: Φ 18mm	S/S	1000	
SPS-096、SPS-105、SPS-363	S: Φ 18mm	S/S	1000	







Tubes-Religieuse,Close		罗密欧花嘴, 弯齿		
REL-795	L: Φ 40mm	S/S	1000	
REX-795	X: Φ 56mm	S/S	1000	







Tubes-Religieuse,Open		罗密欧花嘴, 直齿		
REL-796	L: Φ 40mm	S/S	1000	
REX-796	X: Φ 56mm	S/S	1000	

Decoration Tubes-16 Pcs Set		花嘴, 16件装		
TIP-AT-16/001-CP-CP	N/A	S/S	48	



Decoration Tubes-20 Pcs Set		花嘴, 20件装		
TIP-AT-20/001-CP-CP	N/A	S/S	48	



Decoration Tubes-29 Pcs Set		花嘴, 29件装	
TIP-AT-29/001-CP-CP	N/A	<input type="radio"/>	24
TIP-AT-29/002-CP-CP	N/A	<input type="radio"/>	24



Decoration Tubes-56 Pcs Set		花嘴, 56件装	
TIP-AT-56/001-CP-CP	N/A	<input type="radio"/>	24
TIP-AT-56/002-CP-CP	N/A	<input type="radio"/>	24



Decoration Tubes-40 Pcs Set		花嘴, 40件装	
TIP-AT-40/002-CP-CP	N/A	<input type="radio"/>	24



Tube Adaptor(Nozzle)		奶油嘴转换器	
PN-LARGE-03/002-CP-CP	Large (大号)	<input type="radio"/>	500
PN-SMALL-02/003-CP-CP	Small (小号)	<input type="radio"/>	500
PN-XLARGE-02/001-CP-CP	XLarge (加大号)	<input type="radio"/>	500

Seamless Design With 100% Hygiene Protection







Pastry Bag		奶油袋	
PBEU-250-CP-CP	10"(250mm)	<input type="radio"/>	96
PBEU-300-CP-CP	12"(300mm)	<input type="radio"/>	96
PBEU-350-CP-CP	14"(350mm)	<input type="radio"/>	96
PBEU-400-CP-CP	16"(400mm)	<input type="radio"/>	96
PBEU-450-CP-CP	18"(450mm)	<input type="radio"/>	96
PBEU-530-CP-CP	21"(530mm)	<input type="radio"/>	96
PBEU-560-CP-CP	22"(560mm)	<input type="radio"/>	96
PBEU-610-CP-CP	24"(610mm)	<input type="radio"/>	96
PBEU-660-CP-CP	26"(660mm)	<input type="radio"/>	96
PBEU-710-CP-CP	28"(710mm)	<input type="radio"/>	96



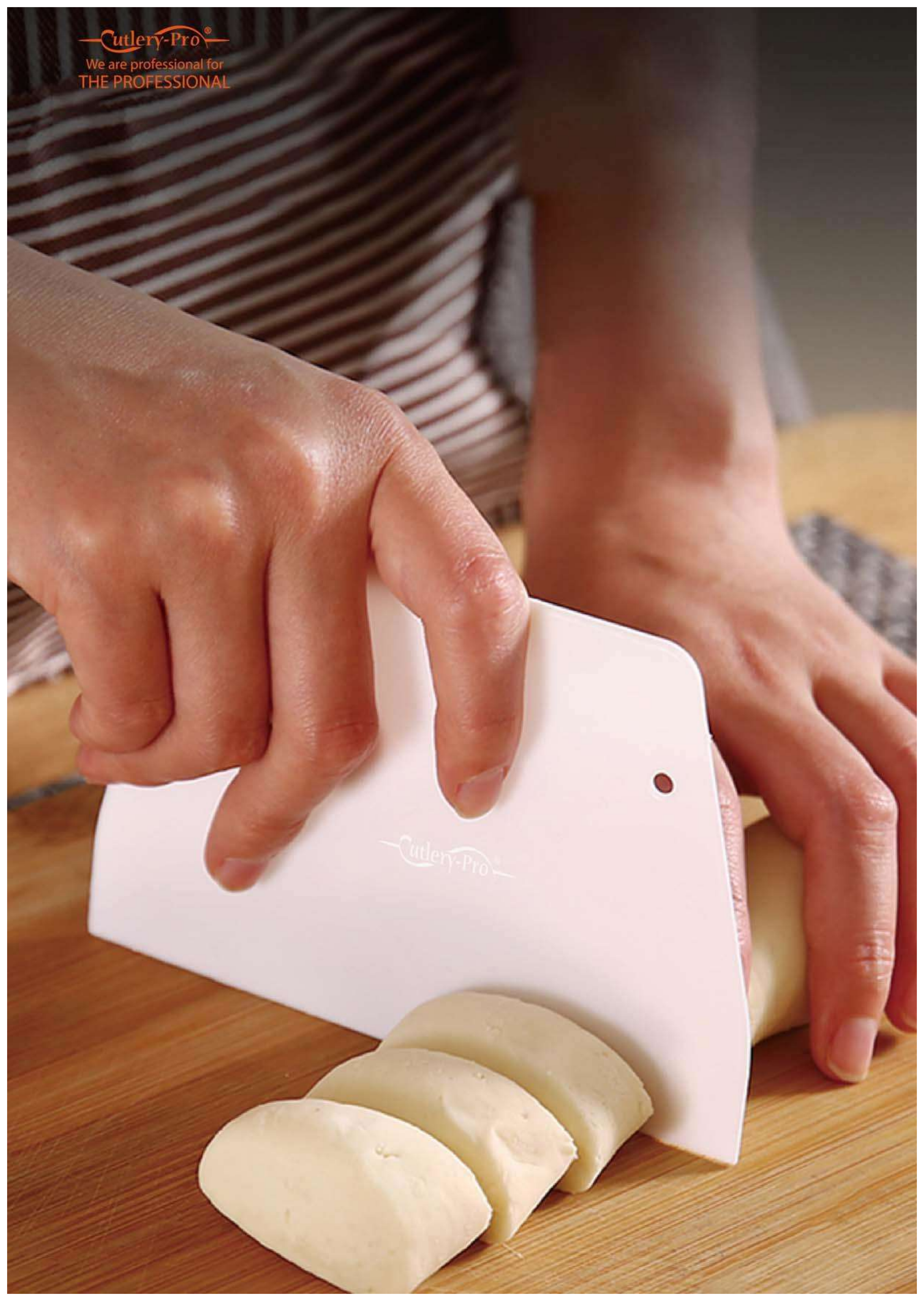



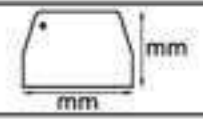



Wall Rack for Pastry Bag -S/S		奶油袋挂架, 不锈钢	
SS-HANG-02-CP-CP	N/A	S/S	5

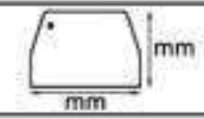



Cutlery-Pro®
We are professional for
THE PROFESSIONAL

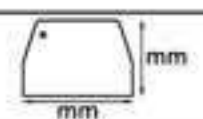





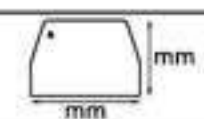



Scraper-PP		塑胶刮		
				
SCP-PP-01-CP-CP	194x127mm	●	500	
SCP-PP-02-CP-CP	155x107mm	○	500	
SCP-PP-03-CP-CP	136x97mm	●	500	

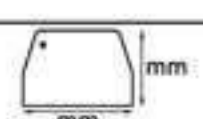



Scraper-PP		塑胶刮		
				
SCP-PP-05-CP-CP	136x97mm	●	500	

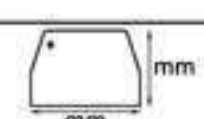



Scraper-PP		塑胶刮		
				
SCP-PP-05-CP-CP	136x97mm	●	500	

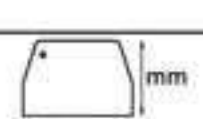



Scraper-PP		塑胶刮		
				
SCP-PP-07-CP-CP	126x97mm	●	500	

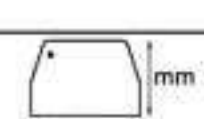



Scraper-PP		塑胶刮		
				
SCP-PP-09-CP-CP	104x74mm	●	500	
SCP-PP-10-CP-CP	155x107mm	○	500	

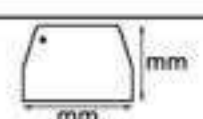



Scraper-PP		塑胶刮		
				
SCP-PP-11-CP-CP	110x72mm	●	500	

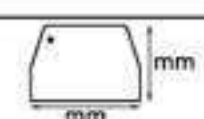



Scraper-PP		塑胶刮		
				
SCP-PP-12-CP-CP	130x100mm	●	500	

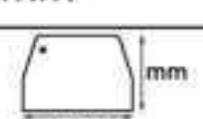



Scraper-PP		塑胶刮		
				
SCP-PP-13-CP-CP	130x100mm	●	500	

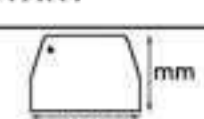

Scraper-PP		塑胶刮		
				
SCP-PP-16-CP-CP	95x95mm	●	500	

Scraper-PP		塑胶刮		
				
SCP-PP-18-CP-CP	196x140mm	●	250	

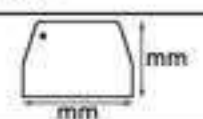
Scraper-S/S, 110x110mm		切丝刮, 不锈钢		
				
SCP-SS-30-CP-CP	110x110mm	S/S	288	

Scraper-S/S, 110x109mm		切丝刮, 不锈钢		
				
SCP-SS-31-CP-CP	110x109mm	S/S	288	

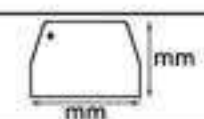
Scraper-S/S, 102x69mm		切丝刮, 不锈钢		
				
SCP-SS-32-CP-CP	102x69mm	S/S	288	

Scraper-S/S		切丝刮, 不锈钢		
				
SCP-SS-33-CP-CP	150x115mm	●	48	

Cutlery-Pro®
We are professional for
THE PROFESSIONAL

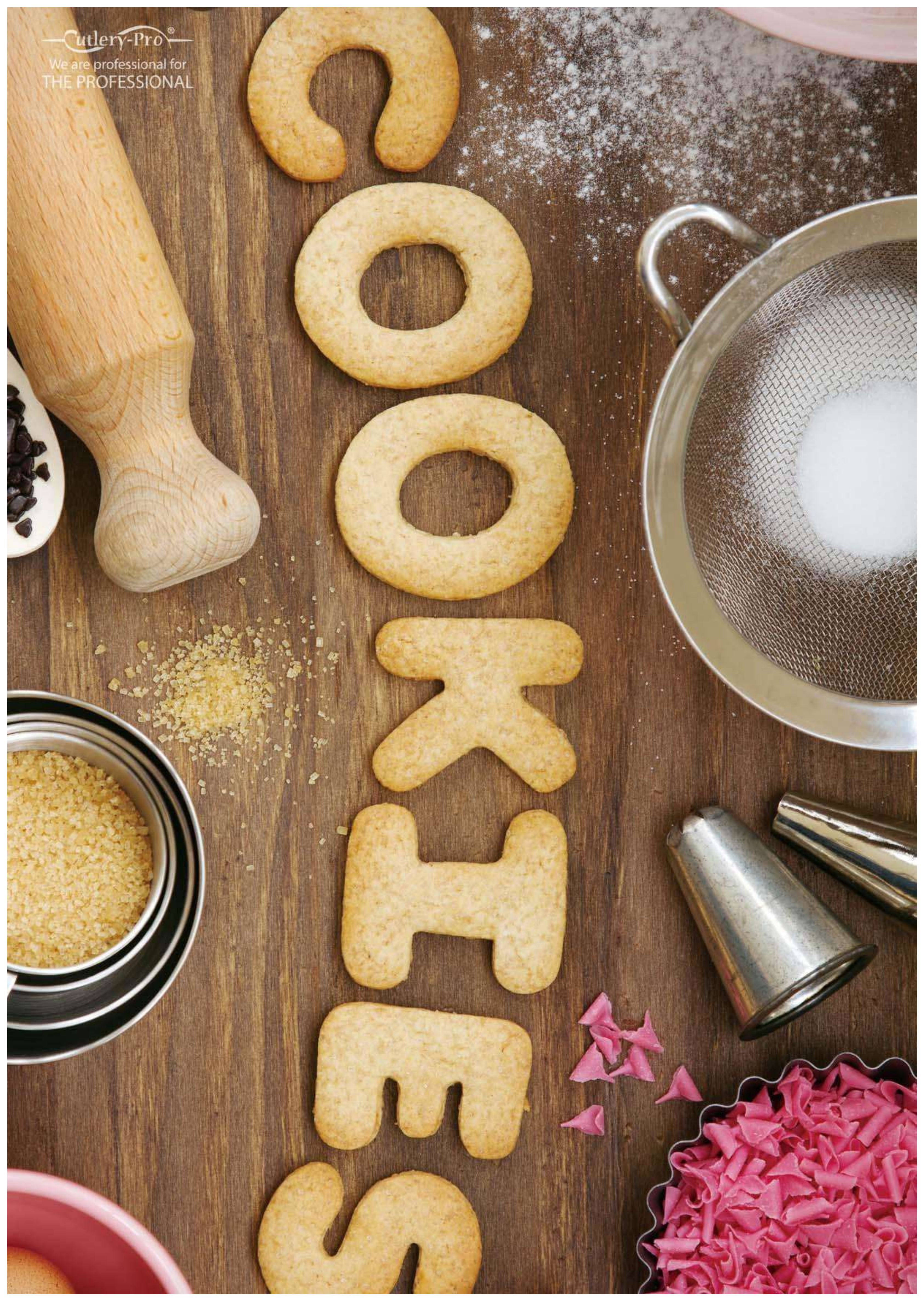

Utensils

Pastry Cutter
-Round,Plain,11 Pcs Set,30mm 饼模,圆形,平口,11件装,30mm

FDMS-RD-11/301-CP-CP Height:30mm S/S 24



Pastry Cutter
-Round,Serrated,11 Pcs Set,30mm 饼模,圆形,齿,11件装,30mm

FDMS-RD-11/302-CP-CP Height:30mm S/S 24



Pastry Cutter
-Round,Plain,12 Pcs Set,52mm 饼模,圆形,平口,12件装,52mm

FDMS-RD-12/501-CP-CP Height:52mm S/S 24



Pastry Cutter
-Round,Serrated,12 Pcs Set,52mm 饼模,圆形,齿,12件装,52mm

FDMS-RD-12/502-CP-CP Height:52mm S/S 24



Pastry Cutter
-Oval,Plain,8 Pcs Set,52mm 饼模,椭圆形,平口,8件装,52mm

FDMS-VL-08/501-CP-CP Height:52mm S/S 24



Pastry Cutter
-Oval,Serrated,8 Pcs Set,52mm 饼模,椭圆形,齿,8件装,52mm

FDMS-VL-08/502-CP-CP Height:52mm S/S 24



Pastry Cutter
-Round,Plain,9 Pcs Set,30mm 饼模,圆形,平口,9件装,30mm

FDMS-RD-09/301-CP-CP Height:30mm S/S 24





Pastry Cutter
-Heart,Plain,9 Pcs Set,30mm 饼模,心形,平口,9件装,30mm

FDMS-HS-09/301-CP-CP Height:30mm S/S 24



Pastry Cutter
-Square,Plain,9 Pcs Set,30mm 饼模,方形,平口,9件装,30mm

FDMS-SQ-09/301-CP-CP Height:30mm S/S 24



Pastry Cutter
-Flower,Plain,9 Pcs Set,30mm 饼模,花形,平口,9件装,30mm

FDMS-FL-09/301-CP-CP Height:30mm S/S 24



Pastry Cutter
-Star,Plain,9 Pcs Set,30mm 饼模, 星形, 平口, 9件装, 30mm

  mm  

FDMS-ST-09/301-CP-CP Height:30mm S/S 24



Pastry Cutter
-Triangle,Plain,9 Pcs Set,30mm 饼模, 三角形, 平口, 9件装, 30mm

  mm  

FDMS-TR-09/301-CP-CP Height:30mm S/S 24



Pastry Cutter
-Round,Plain,6 Pcs Set,50mm 饼模, 圆形, 平口, 6件装, 50mm

  mm  

FDMS-RD-06/501-CP-CP Height:50mm S/S 24







Pastry Cutter
-Heart,Plain,7 Pcs Set,50mm 饼模, 心形, 平口, 7件装, 50mm

  mm  

FDMS-HS-07/501-CP-CP Height:50mm S/S 24



Pastry Cutter
-Square,Plain,6 Pcs Set,50mm 饼模, 方形, 平口, 6件装, 50mm

  mm  

FDMS-SQ-06/501-CP-CP Height:50mm S/S 24



Pastry Cutter
-Flower,Plain,8 Pcs Set,50mm 饼模, 花形, 平口, 8件装, 50mm

  mm  

FDMS-FL-08/501-CP-CP Height:50mm S/S 24



Pastry Cutter
-Star,Plain,6 Pcs Set,50mm 饼模, 星形, 平口, 6件装, 50mm

  mm  

FDMS-ST-06/501-CP-CP Height:50mm S/S 24



Pastry Cutter
-Triangle,Plain,6 Pcs Set,50mm 饼模, 三角形, 平口, 6件装, 50mm

  mm  

FDMS-TR-06/501-CP-CP Height:50mm S/S 24



Pastry Cutter
-Number,9 Pcs Set,17mm 饼模, 数字大码, 9件装, 17mm

  mm  

FDMS-NUB-09/202-CP-CP Height:17mm S/S 24



Pastry Cutter
-Alphabets,26 Pcs Set,20mm 饼模, 字母, 26件装, 20mm

  mm  

FDMS-ALP-26/201-CP-CP Height:20mm S/S 48



Pastry Cutter
-Mini Alphabets,Number,37 Pcs Set 饼模, 数字字母套装, 37件装

FDMS-MAT-37/201-CP-CP Height:20mm S/S 48

1 2 3
A B C
D E F



Pastry Cutter
-Geometry,12 Pcs Set,20mm 饼模, 几何, 12件装, 20mm

FDMS-GEO-12/201-CP-CP Height:20mm S/S 48



Pastry Cutter
-Geometry,24 Pcs Set,20mm 饼模, 几何, 24件装, 20mm

FDMS-GEO-24/201-CP-CP Height:20mm S/S 48



Pastry Cutter
-Butterfly,8 Pcs Set,20mm 饼模, 蝴蝶, 8件装, 20mm

FDMS-BUT-08/201-CP-CP Height:20mm S/S 48



Pastry Cutter
-Animal,10 Pcs Set,20mm 饼模, 动物, 10件装, 20mm

FDMS-ANI-10/201-CP-CP Height:20mm S/S 48



Tart Ring
-Rectangle, Adjustable, S/S 慕斯圈, 长方形, 伸缩, 不锈钢

TARING-RT-5334/5-CP-CP Min: 340x180x50mm S/S 12
Max: 530x280x50mm



Tart Ring
-Round,Adjustable,layer, S/S 慕斯圈, 圆形, 伸缩, 分层, 不锈钢

TARING-RD-2016/8L-CP-CP Min: Φ160mm S/S 12
Max: Φ200mm
TARING-RD-3024/8L-CP-CP Min: Φ240mm S/S 12
Max: Φ300mm



Utensils

Bear Claw Cutter
-PP 分条刀, 方形, PP, 60mm/120mm

BCC-PPP-60-CP-CP	60mm	●	72
BCC-PPP-120-CP-CP	120mm	●	72

Lattice Cutting Rollers
-PP 分条刀, 圆形, PP, 60mm/120mm

LCR-PPP-60-CP-CP	60mm	●	72
LCR-PPP-120-CP-CP	120mm	●	72

Roller Dockers
-PP 分条刀, 针刺形, PP, 60mm/120mm

RD-PPP-60-CP-CP	60mm	●	72
RD-PPP-120-CP-CP	120mm	●	72

Roller Dockers
-PP 分条刀, 针刺形, PP, 60mm/120mm

RD-PPP-60-CP-CP	60mm	●	72
RD-PPP-120-CP-CP	120mm	●	72

Dough Docker
-PP Handle, 70mm 分条刀, 圆粒形, PP柄, 70mm

DD-PSP-70-OR103-CP-CP	70mm	●	24

New!

Dough Docker
-PP Handle, 120mm 分条刀, 圆粒形, PP柄, 120mm

DD-PSP-120-OR103-CP-CP	120mm	●	24

New!

Lattice Cutting Rollers
-S/S, PP Handle, 70mm 分条刀, 圆形, 不锈钢件, PP柄, 70mm

LCR-SSP-70-OR103-CP-CP	70mm	●	24

New!

Lattice Cutting Rollers
-S/S, PP Handle, 120mm 分条刀, 圆形, 不锈钢件, PP柄, 120mm

LCR-SSP-120-OR103-CP-CP	120mm	●	24

New!

Roller Docker
-PP Handle, 70mm 分条刀, 针刺形, PP柄, 70mm

LCR-SSP-70-OR103-CP-CP	70mm	●	24

New!

Roller Docker
-PP Handle, 120mm 分条刀, 针刺形, PP柄, 120mm

RD-ASP-120-OR103-CP-CP	120mm	●	24

New!



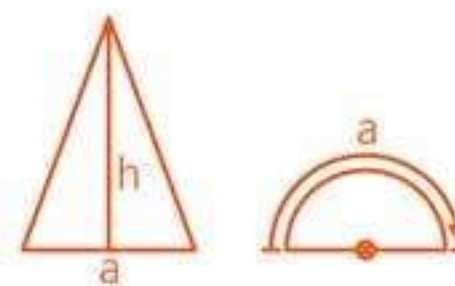

Triangular Croissant Cutters		法式切包器, 单旋	
-Single			
TCC-S05-07/10-OR103-CP-CP	N/A	●	12
TCC-S05-12/21-OR103-CP-CP	N/A	●	12

New!

Triangular Croissant Cutters		法式切包器, 单旋	
-Single			
TCC-S05-12/15-OR103-CP-CP	N/A	●	20
TCC-S05-18/14-OR103-CP-CP	N/A	●	12
TCC-S05-18/20-OR103-CP-CP	N/A	●	12

New!

Triangular Croissant Cutters		法式切包器, 三旋	
-Triple			
TCC-T05-18/20-OR103-CP-CP	N/A	●	6

New!

Triangular Croissant Cutters		法式切包器, 两旋	
-Double			
TCC-D05-18/20-OR103-CP-CP	N/A	●	9

New!

Expandable Dough Cutter		七轮刀, 平口	
-7 Wheels, Plain			
ADD-7W-P-CP-CP	N/A	S/S	24

Expandable Dough Cutter		五轮刀 (平口/平口及齿)	
-5 Wheels (Plain/Plain & Serrated)			
ADD-5W-P-CP-CP	N/A	S/S	24
ADD-5W-S&P-CP-CP	N/A	S/S	24

Expandable Dough Cutter		五轮刀, 加厚 (平口/平口及齿)	
-5 Wheels, Thick Gauge (Plain/Plain & Serrated)			
ADD-5W-P-TG-CP-CP	N/A	S/S	24
ADD-5W-S&P-TG-CP-CP	N/A	S/S	16

Expandable Dough Cutter		五轮刀, 平口, 宽, 加厚	
-5 Wheels, Plain, Wide, Thick Gauge			
ADD-5W-BP-TG-CP-CP	N/A	S/S	24

Expandable Dough Cutter		7轮刀, 加厚 (平口/平口及齿)	
-7 Wheels, Thick Gauge (Plain/Plain & Serrated)			
ADD-7W-P-TG-CP-CP	N/A	S/S	24
ADD-7W-S&P-TG-CP-CP	N/A	S/S	16



Cake Maker 分蛋糕刀

Shopping Cart	mm	Icon	Box
TCM-S08-CP-CP	8 Portions/切	S/S	24
TCM-S10-CP-CP	10 Portions/切	S/S	24
TCM-S12-CP-CP	12 Portions/切	S/S	24
TCM-S14-CP-CP	14 Portions/切	S/S	24
TCM-S16-CP-CP	16 Portions/切	S/S	24
TCM-S18-CP-CP	18 Portions/切	S/S	24



Pie Maker 分饼刀

Shopping Cart	mm	Icon	Box
PIC-6-CP-CP	6 Portions/切	S/S	24
PIC-7-CP-CP	7 Portions/切	S/S	24
PIC-8-CP-CP	8 Portions/切	S/S	24



French Whips 打蛋器, 不锈钢, 粗线, 连挂钩

-S/S With Hanger

Shopping Cart	mm	Icon	Box
FW-10H-CP-CP	10"(250mm)	S/S	48
FW-12H-CP-CP	12"(300mm)	S/S	48
FW-14H-CP-CP	14"(350mm)	S/S	48
FW-16H-CP-CP	16"(400mm)	S/S	48
FW-18H-CP-CP	18"(460mm)	S/S	48
FW-20H-CP-CP	20"(510mm)	S/S	48
FW-22H-CP-CP	22"(560mm)	S/S	48
FW-24H-CP-CP	24"(610mm)	S/S	48



Φ 2.2mm/8 Wire

Piano Whips 打蛋器, 不锈钢, 细线, 连挂钩

-S/S With Hanger

Shopping Cart	mm	Icon	Box
PW-10H-CP-CP	10"(250mm)	S/S	48
PW-12H-CP-CP	12"(300mm)	S/S	48
PW-14H-CP-CP	14"(350mm)	S/S	48
PW-16H-CP-CP	16"(400mm)	S/S	48
PW-18H-CP-CP	18"(460mm)	S/S	48



Φ 1.4mm/12 Wire

French Whips 打蛋器, 不锈钢, 粗线, 连环氧树脂, NSF

-S/S With Epoxy, NSF

Shopping Cart	mm	Icon	Box
FW-10D-CP-CP	10"(250mm)	S/S	48
FW-12D-CP-CP	12"(300mm)	S/S	48
FW-14D-CP-CP	14"(350mm)	S/S	48
FW-16D-CP-CP	16"(400mm)	S/S	48
FW-18D-CP-CP	18"(460mm)	S/S	48
FW-20D-CP-CP	20"(510mm)	S/S	48
FW-22D-CP-CP	22"(560mm)	S/S	48
FW-24D-CP-CP	24"(610mm)	S/S	48



Φ 2.2mm/8 Wire

Piano Whips 打蛋器, 不锈钢, 细线, 连环氧树脂, NSF

-S/S With Epoxy, NSF

Shopping Cart	mm	Icon	Box
PW-8D-CP-CP	8"(200mm)	S/S	48
PW-10D-CP-CP	10"(250mm)	S/S	48
PW-12D-CP-CP	12"(300mm)	S/S	48
PW-14D-CP-CP	14"(350mm)	S/S	48
PW-16D-CP-CP	16"(400mm)	S/S	48
PW-18D-CP-CP	18"(460mm)	S/S	48



Φ 1.4mm/12 Wire

French Whips 打蛋器, 粗线, PP, NSF

-PP, NSF

Shopping Cart	mm	Icon	Box
GS-608-FW-10-CP-CP	10"(250mm)	S/S	48
GS-608-FW-12-CP-CP	12"(300mm)	S/S	48
GS-608-FW-14-CP-CP	14"(350mm)	S/S	48
GS-608-FW-16-CP-CP	16"(400mm)	S/S	48
GS-608-FW-18-CP-CP	18"(460mm)	S/S	48
GS-608-FW-20-CP-CP	20"(510mm)	S/S	48
GS-608-FW-22-CP-CP	22"(560mm)	S/S	48
GS-608-FW-24-CP-CP	24"(610mm)	S/S	48



Φ 2.2mm/6 Wire

Piano Whips 打蛋器, 细线, PP, NSF

-PP, NSF

Shopping Cart	mm	Icon	Box
GS-608-PW-10-CP-CP	10"(250mm)	S/S	48
GS-608-PW-12-CP-CP	12"(300mm)	S/S	48
GS-608-PW-14-CP-CP	14"(350mm)	S/S	48
GS-608-PW-16-CP-CP	16"(400mm)	S/S	48
GS-608-PW-18-CP-CP	18"(460mm)	S/S	48
GS-608-PW-20-CP-CP	20"(510mm)	S/S	48
GS-608-PW-22-CP-CP	22"(560mm)	S/S	48
GS-608-PW-24-CP-CP	24"(610mm)	S/S	48



Φ 1.4mm/11 Wire

Kettle Whips
-S/S 打蛋器, 不锈钢, 粗线

KW-48-CP-CP	48"(120cm)	S/S	2



Mayonnaise Whips
-S/S 打蛋器, 不锈钢, 粗线

MW-40-CP-CP	40"(100cm)	S/S	2



Potato Masher
-Round Shape,S/S 压薯器, 不锈钢, 圆形

PM-SR-300-CP-CP	12"(300mm)	S/S	12
PM-SR-460-CP-CP	18"(460mm)	S/S	12
PM-SR-610-CP-CP	24"(610mm)	S/S	12



Potato Masher
-Square Shape,S/S 压薯器, 不锈钢, 方形

PM-SS-300-CP-CP	12"(300mm)	S/S	12
PM-SS-460-CP-CP	18"(460mm)	S/S	12
PM-SS-610-CP-CP	24"(610mm)	S/S	12



Dipping Fork
-10 Pcs Set 巧克力叉, 10件装

DIPF-AT-10/001-CP-CP	N/A	●	24



Marzip-Modelling
-Tools,20 Pcs Set 雕刻刀, 20件装

MMT-AT-20/001-CP-CP	N/A	●	24



Spatula
-Flat Shape,Silicone 刮, 铲形, 硅胶

SCP-PF-250-BR401-CP-CP	10"(250mm)	●	100
SCP-PF-360-BR401-CP-CP	14"(360mm)	●	100
SCP-PF-400-BR401-CP-CP	16"(400mm)	●	100



Spatula
-Spoon Shape,Silicone 刮, 勺形, 硅胶

SCP-PS-250-BR401-CP-CP	10"(250mm)	●	100
SCP-PS-360-BR401-CP-CP	14"(360mm)	●	100
SCP-PS-400-BR401-CP-CP	16"(400mm)	●	100



Silicone Heat Resistant Up to 260°C/ 500°F

Spatula
-Flat Shape,Silicone,High Heat Resistant **NSF** 刮, 铲形, 高温硅胶

Shopping Cart	mm	NSF	Box
SCP-NF-250-BR401-CP-CP	10"(250mm)	●	100
SCP-NF-360-BR401-CP-CP	14"(360mm)	●	100
SCP-NF-400-BR401-CP-CP	16"(400mm)	●	100



Spatula
-Spoon Shape,Silicone,High Heat Resistant **NSF** 刮, 勺形, 高温硅胶

Shopping Cart	mm	NSF	Box
SCP-NS-250-BR401-CP-CP	10"(250mm)	●	100
SCP-NS-360-BR401-CP-CP	14"(360mm)	●	100
SCP-NS-400-BR401-CP-CP	16"(400mm)	●	100



Spatula
-With S/S Wire Handle,Flat Shape,Silicone 刮, 不锈钢线柄, 铲形, 硅胶

Shopping Cart	mm	S/S	Box
SCP-SF-220-CP-CP	8.75"(220mm)	S/S	100
SCP-SF-280-CP-CP	11"(280mm)	S/S	100
SCP-SF-325-CP-CP	12.75"(325mm)	S/S	100



Brush
-With S/S Wire Handle,Silicone 毛扫, 不锈钢线柄, 硅胶

Shopping Cart	mm	S/S	Box
SCB-SW-200-CP-CP	8"(200mm)	S/S	96
SCB-SW-240-CP-CP	10"(240mm)	S/S	96
SCB-SW-285-CP-CP	11.25"(285mm)	S/S	96



Mat
-Silicone,OR 垫, 硅胶, 橙色

Shopping Cart	mm	NSF	Box
SMAT-78-60/40-CP-CP	600 x 400mm	●	48
SMAT-78-51/31-CP-CP	510 x 310mm	●	48
SMAT-78-40/30-CP-CP	400 x 300mm	●	48



Flour Sifter
-S/S 滤筛, 不锈钢

Shopping Cart	mm	S/S	Box
FST-02-CP-CP	2 Cups/杯	S/S	24
FST-03-CP-CP	3 Cups/杯	S/S	24
FST-05-CP-CP	5 Cups/杯	S/S	24

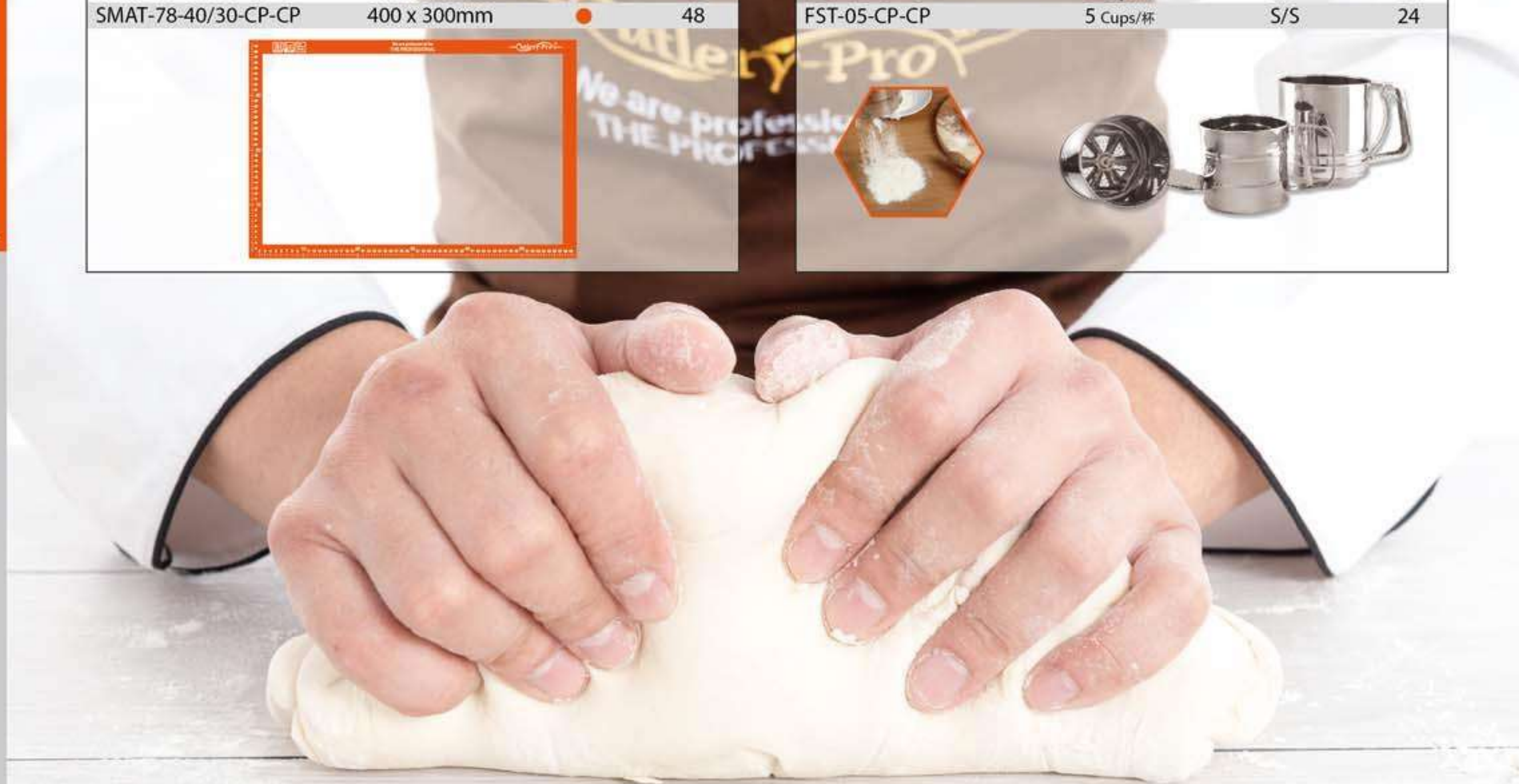
Cutlery-Pro®

We are professional for
THE PROFESSIONAL



www.cutlery-pro.com

All The
Decoration
Tubes

Cutlery Precision Company Limited

✉ cutlery@netvigator.com

📘 www.facebook.com/cutlerypro

📷 www.instagram.com/cutlerypro/

📺 www.youtube.com/@cutlery-pro.com



MADE FOR
BUTCHERS

Cutlery-Pro®

Cutlery-Pro®
We are professional for
THE PROFESSIONAL

QINGSHANJI®